

## American Standard AMERICAST ACRYLIC WHIRLPOOLS

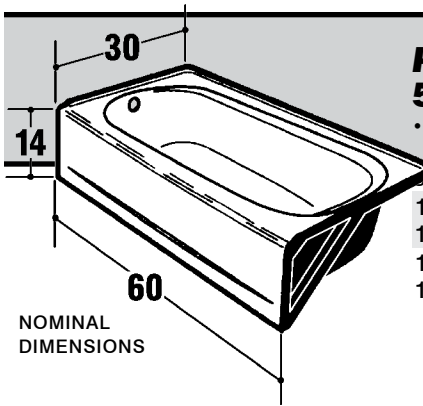

### PRINCETON 5' AMERICAST RECESS BATH

•SLIP RESISTANT SUMP PATTERN •PORCELAIN ENAMEL

SSC No.	Manuf. No.	Color		Wgt	Price Each
10A 2400	<b>2390.202.020</b>	White	Left Hand Outlet	140 Lbs	\$ 459.21
10A 2410	<b>2390.202.021</b>	Bone	Left Hand Outlet	140 Lbs	599.50 *
10A 2500	<b>2391.202.020</b>	White	Right Hand Outlet	140 Lbs	459.21
10A 2510	<b>2391.202.021</b>	Bone	Right Hand Outlet	140 Lbs	599.50 *

NOMINAL DIMENSIONS

### CADET ACRYLIC WHIRLPOOLS

WITH HYDROMASSAGE FEATURING SYSTEM I • WITH OR WITHOUT EverClean® System  
 •WHITE •ACRYLIC WITH FIBERGLASS REINFORCEMENT •1 HP PUMP/MOTOR  
 •8 MULTI-DIRECTINAL & INDIVIDUALLY FLOW-RATE ADJUSTABLE JETS - 2 IN THE LUMBAR AREA  
 •2 AIR VOLUME CONTROLS •DECK-MOUNTED AIR SWITCH ON/OFF

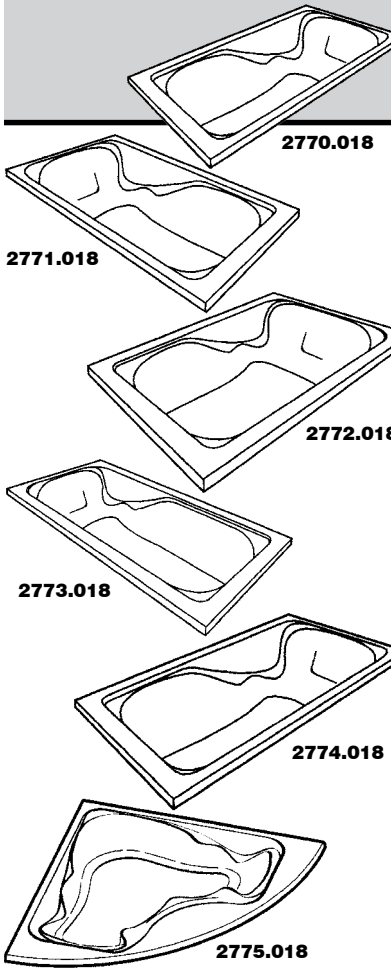

SSC No.	Manuf. No.	Size	Wgt Lbs
<b>CADET 5' X 32" WHIRLPOOL</b>			
10A 5000	<b>2770.018W or WC</b> EverClean®	59 <sup>1</sup> / <sub>2</sub> " x 31 <sup>1</sup> / <sub>2</sub> " x 19 <sup>3</sup> / <sub>4</sub> "	149
<b>CADET 5' X 36" WHIRLPOOL</b>			
	<b>2771.018W or WC</b> EverClean®	59 <sup>1</sup> / <sub>2</sub> " x 36" x 19 <sup>3</sup> / <sub>4</sub> "	160
<b>CADET 5' X 42" WHIRLPOOL</b>			
	<b>2772.018W or WC</b> EverClean®	59 <sup>1</sup> / <sub>2</sub> " x 41 <sup>1</sup> / <sub>2</sub> " x 19 <sup>3</sup> / <sub>4</sub> "	148
<b>CADET 6' X 36" WHIRLPOOL</b>			
	<b>2773.018W or WC</b> EverClean®	6" x 35 <sup>3</sup> / <sub>4</sub> " x 19 <sup>3</sup> / <sub>4</sub> "	162
<b>CADET 6' X 42" WHIRLPOOL</b>			
	<b>2774.018W or WC</b> EverClean®	71 <sup>3</sup> / <sub>4</sub> " x 41 <sup>3</sup> / <sub>4</sub> " x 19 <sup>3</sup> / <sub>4</sub> "	188
<b>CADET CORNER WHIRLPOOL WITH DUAL LUMBAR BACK RESTS</b>			
	<b>2775.018W or WC</b> EverClean®	5' x 5' x 19 <sup>3</sup> / <sub>4</sub> "	188
10A 5500	<b>751755-100</b>	<b>UNIVERSAL TILE KIT</b>	

For More Information & Prices On These Cadet Whirlpools Call The Salina Supply Company Order Desk At (785) 823-2221

### EverClean® System

The EverClean system, exclusively from American Standard, is the easiest way to help keep your whirlpool system clean.

- Patented silver-ion additive is molded directly into the circulation piping protecting them from mold, mildew, algae and fungus that could cause deterioration or staining.
- Will not wear off & works around the clock no matter how often you use your whirlpool.
- Competitive whirlpool cleaning systems using ozone operate only while the motor is running which will not help when water gets into the jets or piping during bathing.



*American Standard* ENAMELED STEEL Note: All Prices On This Page Have Changed  
\*\* Desc. Change

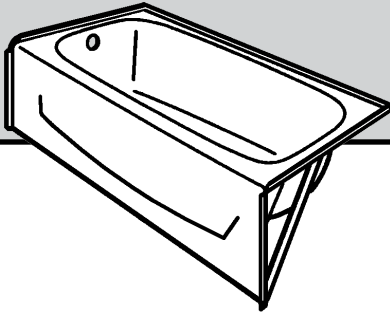

### NEW SALEM 5' ONE PIECE RECESS BATH

•PORCELAIN ON STEEL CONSTRUCTION •CONVENTIONAL INSTALLATION •INTEGRAL APRON  
•FULL SLIP-RESISTANT SURFACE •60" X 30" X 14<sup>1</sup>/<sub>4</sub>"

SSC No.	Manuf. No.	Color	Outlet	Wgt	Price Each
10D 3100	<b>0255.102.020</b>	White	Right Hand	112 Lbs	\$ 307.32 **
10D 3110	<b>0255.102.021</b>	Bone	Right Hand	112 Lbs	338.42 **
10D 4100	<b>0255.202.020</b>	White	Left Hand	112 Lbs	307.32 **
10D 4110	<b>0255.202.021</b>	Bone	Left Hand	112 Lbs	338.42 **

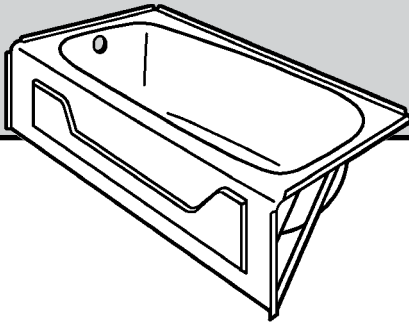

### MACKENZIE 4<sup>1</sup>/<sub>2</sub>' ONE PIECE RECESS BATH

•PORCELAIN ON STEEL CONSTRUCTION •CONVENTIONAL INSTALLATION •INTEGRAL APRON  
•FULL SLIP-RESISTANT SURFACE •FULLY BONDED SUPPORT PAD •54" X 30" X 15"

SSC No.	Manuf. No.	Color	Outlet	Wgt	Price Each
10D 4150	<b>0139.011.020</b>	White	Left Hand	100 Lbs	\$ 438.11
10D 5100	<b>0138.014.020</b>	White	Right Hand	100 Lbs	438.11

## STEAMIST

- RESIDENTIAL STEAM GENERATORS • COMMERCIAL STEAM GENERATORS
- STEAM BATH FIXTURES • STEAM BATH DIGITAL CONTROLS • STEAM BATH ACCESSORIES
- AROMA THERAPY • SAUNA HEATERS & CONTROLS • CUSTOM CUT & MODULAR SAUNAS

For More Information On These Products Or On Products Not Listed,  
Call *Salina Supply Company* At (785) 823-2221



## VIKRELL TUB & SHOWERS

Note: All Prices On This Page Have Changed

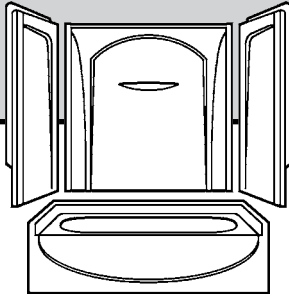

### ACCLAIM™ 60" X 30" COMPLETE TUB & SHOWER

**SERIES 7109** HIGH GLOSS • 15" DEEP TUB, 2 END WALLS & BACK WALL WITH SHELVING  
 WATER TIGHT SEAL WITHOUT CAULK OR GROUT • RIGHT OR LEFT HAND MODELS  
**60" LONG x 30" WIDE x 72" HIGH**

SSC No.	Manuf. No.	Color		Wgt	Price Each
10D 6100	<b>7109</b>	White	Right Hand	140 Lbs	\$ 510.38
10D 6200	<b>7109</b>	White	Left Hand	140 Lbs	510.38
10D 6250	<b>7109</b>	Linen	Right Hand	140 Lbs	\$ 561.37
10D 6225	<b>7109</b>	Linen	Left Hand	140 Lbs	561.37

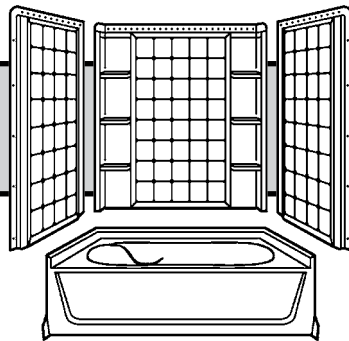

### ENSEMBLE™ 60" X 36" COMPLETE TUB & SHOWER

**SERIES 7110** HIGH GLOSS • 16" DEEP OVAL TUB, 2 END WALLS & BACK WALL WITH SHELVING  
 REALISTIC 6" x 6" SIMULATED TILE • WATER TIGHT SEAL WITHOUT CAULK OR GROUT • RIGHT OR LEFT HAND  
**60" LONG x 36" WIDE x 72" HIGH**

SSC No.	Manuf. No.	Color		Wgt	Price Each
10D 6300	<b>7110</b>	White	Right Hand	141 Lbs	\$ 738.86
10D 6400	<b>7110</b>	White	Left Hand	141 Lbs	738.86

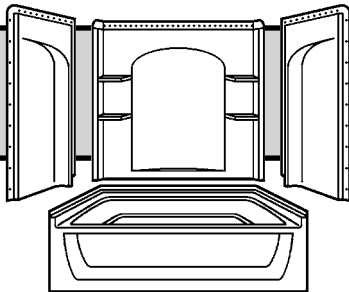

### ENSEMBLE™ 60" X 32" COMPLETE TUB & SHOWER

**SERIES 7122** HIGH GLOSS • 18" DEEP TUB & CURVE WALL SURROUND (2 END WALLS & BACK WALL)  
 BACK WALL WITH SHELVING • WATER TIGHT SEAL WITHOUT CAULK OR GROUT • RIGHT OR LEFT HAND  
**60" LONG x 32" WIDE x 72" HIGH**

SSC No.	Manuf. No.	Color		Wgt	Price Each
10D 6450	<b>7122</b>	White	Right Hand	160 Lbs	\$ 577.60
10D 6425	<b>7122</b>	White	Left Hand	160 Lbs	577.60
10D 6470	<b>7122</b>	Biscuit	Right Hand	160 Lbs	\$ 635.25
10D 6460	<b>7122</b>	Biscuit	Left Hand	160 Lbs	635.25

For More Information On These Products Or On Products Not Listed,  
 Call *Salina Supply Company* At (785) 823-2221

Continued On Next Page



**ADA VIKRELL SHOWERS • FIBERGLASS TUB & SHOWERS • TUB**

Note: All Prices On This Page Have Changed

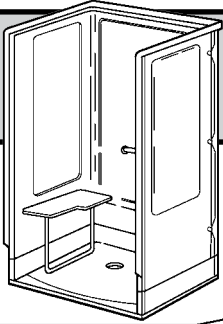

**ADA ACCESSIBLE TRANSFER 39" VIKRELL SHOWER**

4 PIECES • SWIRL GLOSS SOLID VIKRELL • STRUCTURALLY REINFORCED STAINLESS STEEL GRAB BARS  
 39<sup>3</sup>/<sub>8</sub>" LONG x 40<sup>5</sup>/<sub>8</sub>" WIDE x 73<sup>9</sup>/<sub>16</sub>" HIGH • INTERIOR 36" x 36" x 72" • THRESHOLD HGT (INSTALLED) <sup>5</sup>/<sub>8</sub>"

SSC No.	Manuf. No.	Color		Wgt	Price Each
10D 8000	<b>OC-SS-39 RH</b>	White	Right Hand Bar	145 Lbs	\$ 2264.84
10D 8050	<b>OC-SS-39 LH</b>	White	Left Hand Bar	145 Lbs	2264.84

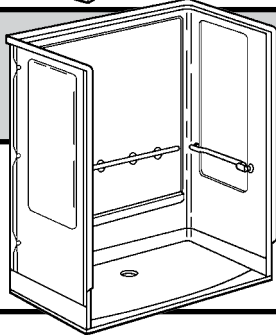

**ADA ACCESSIBLE ROLL-IN 63" VIKRELL SHOWER**

4 PIECES • SWIRL GLOSS SOLID VIKRELL • STRUCTURALLY REINFORCED STAINLESS STEEL GRAB BARS  
 63<sup>5</sup>/<sub>16</sub>" LONG x 40<sup>5</sup>/<sub>8</sub>" WIDE x 74" HIGH • INTERIOR 60" x 36" x 72" • THRESHOLD HGT (INSTALLED) <sup>1</sup>/<sub>2</sub>"

SSC No.	Manuf. No.	Color		Wgt	Price Each
10D 6000	<b>OC-SS-63</b>	White		183 Lbs	\$ 1973.83

**IMPORTANT NOTE!**  
**OPENED SHOWER DOOR CARTONS & SPECIAL ORDER SHOWER DOORS ARE NON-RETURNABLE**

For More Information On These Products Or On Products Not Listed,  
 Call *Salina Supply Company* At (785) 823-2221

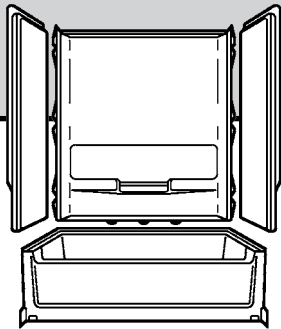

**ADVANTAGE FIBERGLASS TUB & SHOWER**

SWIRL GLOSS MOLDED FIBERGLASS COMPONENTS • WITH 18" TOWEL BAR  
 60" x 32" x 15" TUB • 72" HIGH • DOOR OPENING 56<sup>1</sup>/<sub>4</sub>" x 56<sup>3</sup>/<sub>8</sub>"

SSC No.	Manuf. No.	Color		Wgt	Price Each
10D 8400	<b>OC-AP-TS RH</b>	White	Right Hand	115 Lbs	\$ 480.94
10D 8405	<b>OC-AP-TS RH</b>	Almond	Right Hand	115 Lbs	537.24
10D 8450	<b>OC-AP-TS LH</b>	White	Left Hand	115 Lbs	480.94
10D 8455	<b>OC-AP-TS LH</b>	Almond	Left Hand	115 Lbs	537.24

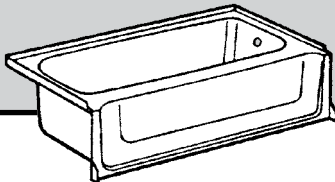

**ALL PRO FIBERGLASS BATHTUB**

SWIRL GLOSS MOLDED FIBERGLASS • TEXTURED SURFACE • SLIP RESISTANT BOTTOM  
 60" x 30<sup>1</sup>/<sub>2</sub>" x 15" TUB

SSC No.	Manuf. No.	Color		Wgt	Price Each
10D 8652	<b>OC-15-60R</b>	White	Right Hand	57 Lbs	\$ 178.40
10D 8656	<b>OC-15-60R</b>	Almond	Right Hand	57 Lbs	196.25
10D 8654	<b>OC-15-60L</b>	White	Left Hand	57 Lbs	178.40
10D 8658	<b>OC-15-60L</b>	Almond	Left Hand	57 Lbs	196.25

Continued On Next Page





## FIBERGLASS SHOWERS

Note: All Prices On This Page Have Changed

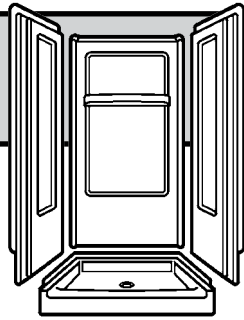

### 32" FIBERGLASS SHOWER

4 SWIRL GLOSS MOLDED FIBERGLASS COMPONENTS  
**DOOR OPENING 29<sup>1</sup>/<sub>2</sub>" x 66<sup>1</sup>/<sub>2</sub>"**

SSC No.	Manuf. No.	Color	Wgt	Price Each
10D 8659	<b>OC-S-32</b>	White	100 Lbs	\$ 510.77
10D 8660	<b>OC-S-32</b>	Bone	100 Lbs	565.83

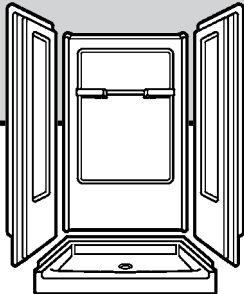

### 36" FIBERGLASS SHOWER

4 SWIRL GLOSS MOLDED FIBERGLASS COMPONENTS • TOWEL BAR ON BACK  
**DOOR OPENING 33<sup>5</sup>/<sub>8</sub>" x 66<sup>1</sup>/<sub>2</sub>"**

SSC No.	Manuf. No.	Color	Wgt	Price Each
10D 8661	<b>OC-S-36</b>	White	122 Lbs	\$ 510.77
10D 8662	<b>OC-S-36</b>	Bone	122 Lbs	565.83

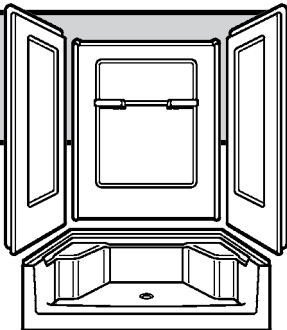

### 48" FIBERGLASS SHOWER

4 SWIRL GLOSS MOLDED FIBERGLASS COMPONENTS • TOWEL BAR ON BACK • TWO SEATS  
**DOOR OPENING 44<sup>3</sup>/<sub>4</sub>" x 66<sup>1</sup>/<sub>2</sub>"**

SSC No.	Manuf. No.	Color	Wgt	Price Each
10D 8620	<b>OC-SS-48</b>	White	115 Lbs	\$ 525.23
10D 8621	<b>OC-SS-48</b>	Almond	115 Lbs	580.29

For More Information On These Products Or On Products Not Listed,  
 Call *Salina Supply Company* At (785) 823-2221

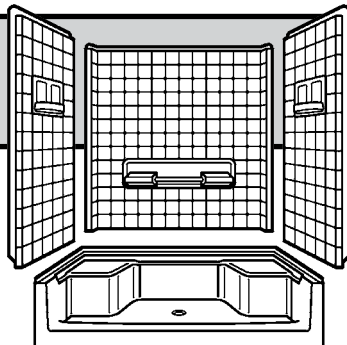

### 60" FIBERGLASS SHOWER

4 SWIRL GLOSS MOLDED COMPONENTS • BASE WITH TWO SEATS & MOLDED IN DRAIN OPENING  
 TWO TILE PATTERNED ENDWALLS SHELVES • BACK WALL WITH 18" TOWEL BAR  
**DOOR OPENING 56<sup>3</sup>/<sub>4</sub>" x 70<sup>1</sup>/<sub>2</sub>"**

SSC No.	Manuf. No.	Color	Wgt	Price Each
10D 8625	<b>OC-SS-60</b>	White	144 Lbs	\$ 570.18
10D 8630	<b>OC-SS-60</b>	Bone	144 Lbs	629.65
10D 8635	<b>OC-SS-60</b>	Biscuit	144 Lbs	629.65

Continued On Next Page



**VIKRELL CORNER SHOWER • ALCOVE SHOWERS**

\*Price Change

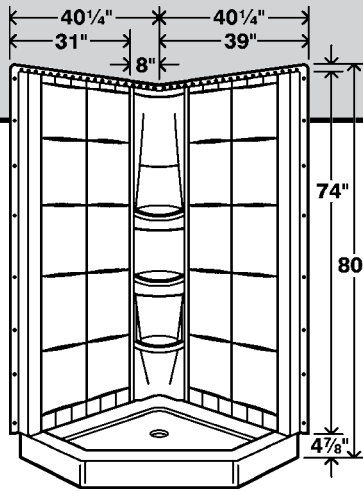

**NEO ANGLE VIKRELL CORNER SHOWER**

4 COMPRESSION MOLDED HIGH GLOSS VIKRELL COMPONENTS • LIGHTLY PEBBLED BOTTOM SURFACE  
**DOOR SOLD SEPARATELY:** 72" HEIGHT • 19" DOOR OPENING • CHROME WITH OBSCURE GLASS  
 FULL LENGTH DOOR HANDLE • WATERTIGHT MAGNETIC LATCH

SSC No.	Manuf. No.	Color	Wgt	Price Each
10D 8680	<b>7204</b>	White	87 Lbs	\$ 474.71 *
10D 8690	<b>7204</b>	Bone	87 Lbs	522.26 *
10G 4700	<b>SP2276A-38S</b>	Shower Door Chrome/Obscure	95 Lbs	\$ 534.17

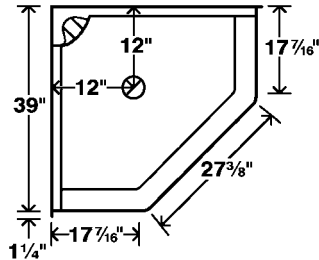

**IMPORTANT NOTE!  
 OPENED SHOWER DOOR CARTONS &  
 SPECIAL ORDER SHOWER DOORS ARE  
 NON-RETURNABLE**

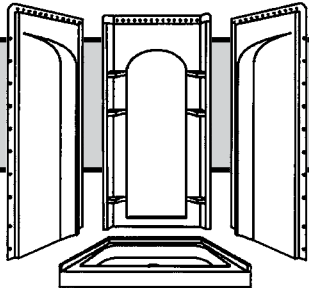

**ENSEMBLE™ 36" CURVE ALCOVE SHOWER**

**SERIES 7220** DURABLE HIGH GLOSS FINISH • RECEPTOR, 2 END WALLS & BACK WALL WITH SHELVING  
 WATER TIGHT SEAL WITHOUT CAULK OR GROUT • LIGHTLY PEBBLED BOTTOM SURFACE  
**36" WIDE x 34" DEEP x 75 3/4" HIGH • COMPLETE**

SSC No.	Manuf. No.	Color	Wgt	Price Each
10D 8820	<b>7220 0100</b>	White	105 Lbs	\$ 507.70 *
10D 8664	<b>7220</b>	Linen	105 Lbs	558.45 *

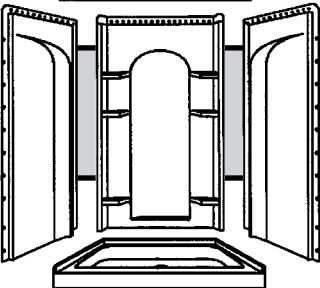

**ENSEMBLE™ 42" CURVE ALCOVE SHOWER**

**SERIES 7221** DURABLE HIGH GLOSS FINISH • RECEPTOR, 2 END WALLS & BACK WALL WITH SHELVING  
 WATER TIGHT SEAL WITHOUT CAULK OR GROUT • LIGHTLY PEBBLED BOTTOM SURFACE  
**42" WIDE x 34" DEEP x 75 3/4" HIGH • COMPLETE**

SSC No.	Manuf. No.	Color	Wgt	Price Each
10D 8840	<b>7221 0100</b>	White	112 Lbs	\$ 554.96 *

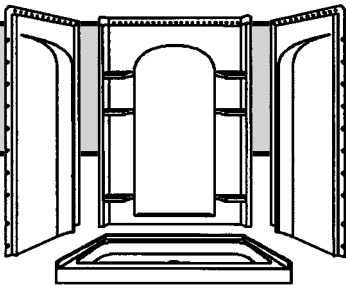

**ENSEMBLE™ 48" CURVE ALCOVE SHOWER**

**SERIES 7222** DURABLE HIGH GLOSS FINISH • RECEPTOR, 2 END WALLS & BACK WALL WITH SHELVING  
 WATER TIGHT SEAL WITHOUT CAULK OR GROUT • LIGHTLY PEBBLED BOTTOM SURFACE  
**48" WIDE x 34" DEEP x 75 3/4" HIGH • COMPLETE**

SSC No.	Manuf. No.	Color	Wgt	Price Each
10D 8860	<b>7222 0100</b>	White	130 Lbs	\$ 554.96 *

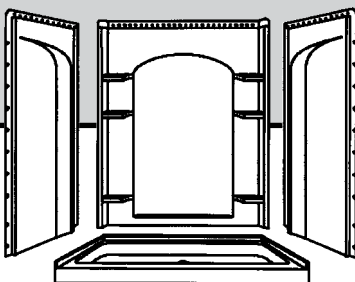

**ENSEMBLE™ 60" CURVE ALCOVE SHOWER**

**SERIES 7223** DURABLE HIGH GLOSS FINISH • RECEPTOR, 2 END WALLS & BACK WALL WITH SHELVING  
 WATER TIGHT SEAL WITHOUT CAULK OR GROUT • LIGHTLY PEBBLED BOTTOM SURFACE  
**60" WIDE x 34" DEEP x 75 3/4" HIGH • COMPLETE**

SSC No.	Manuf. No.	Color	Wgt	Price Each
10D 8880	<b>7223 0100</b>	White	146 Lbs	\$ 640.47 *



**AQUARIUS BATHWARE** **GELCOAT TUB & SHOWERS**

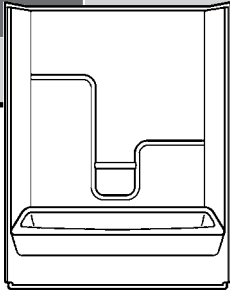

## LUXURY GELCOAT 32" ONE PIECE TUB & SHOWER

GELCOAT TUB & SHOWER WITH ACRYLIC TOWEL BAR.

LENGTH: 59.875" WIDTH: 32.75" HEIGHT: 73.5" SHOWER BYPASS ENCLOSURE: UP TO 55.75" W X 56.5" H

SSC No.	Manuf. No.		Color	Wgt	Price Each
10B 1000	<b>G 6004 TS RH</b>	<b>Right Hand Valve Wall</b>	White	125 Lbs	\$ 449.95
10B 1050	<b>G 6004 TS RH</b>	<b>Right Hand Valve Wall</b>	Linen	125 Lbs	449.95
10B 1100	<b>G 6004 TS LH</b>	<b>Left Hand Valve Wall</b>	White	125 Lbs	\$ 449.95
10B 1150	<b>G 6004 TS LH</b>	<b>Left Hand Valve Wall</b>	Linen	125 Lbs	449.95

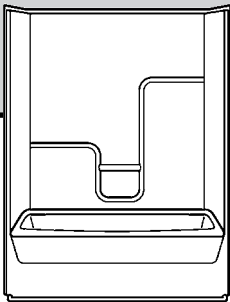

## LUXURY GELCOAT 35" ONE PIECE TUB & SHOWER

EXTREMELY DEEP GELCOAT TUB & SHOWER WITH LUXURIOUS STYLING & DESIGN. ACRYLIC TOWEL BAR.

LENGTH: 60" WIDTH: 35.75" HEIGHT: 76.5" SHOWER BYPASS ENCLOSURE: UP TO 55.5" W X 60" H

SSC No.	Manuf. No.		Color	Wgt	Price Each
10B 1200	<b>G 6063 TS RH</b>	<b>Right Hand Valve Wall</b>	White	140 Lbs	\$ 552.63
10B 1250	<b>G 6063 TS RH</b>	<b>Right Hand Valve Wall</b>	Linen	140 Lbs	552.63
10B 1300	<b>G 6063 TS LH</b>	<b>Left Hand Valve Wall</b>	White	140 Lbs	\$ 552.63
10B 1350	<b>G 6063 TS LH</b>	<b>Left Hand Valve Wall</b>	Linen	140 Lbs	552.63

For More Information On These Products Or On Products Not Listed,  
Call *Salina Supply Company* At (785) 823-2221

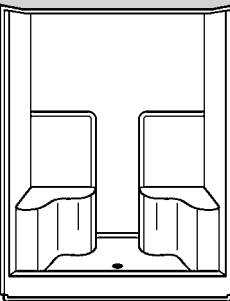

## GELCOAT STANDARD 60" ONE PIECE SEATED SHOWER

STANDARD GELCOAT CENTER DRAIN MODEL WITH TWO LARGE MOLDED SEATS & TWO MOLDED SOAP LEDGES.

LENGTH: 60.5" WIDTH: 36" HEIGHT: 78.5" SHOWER BYPASS ENCLOSURE: UP TO 55.5" W X 69" H

SSC No.	Manuf. No.		Color	Wgt	Price Each
10B 1400	<b>G 6077 SH</b>	<b>Center Drain</b>	White	140 Lbs	\$ 520.89
10B 1450	<b>G 6077 SH</b>	<b>Center Drain</b>	Linen	140 Lbs	520.89

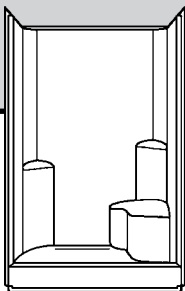

## GELCOAT STANDARD 48" ONE PIECE SEATED SHOWER

STANDARD GELCOAT SHOWER WITH A MOLDED SEAT & TWO MOLDED SOAP LEDGES.

LENGTH: 48" WIDTH: 35.5" HEIGHT: 77.5" SHOWER BYPASS ENCLOSURE: UP TO 44.375" W X 68.75" H

SSC No.	Manuf. No.		Color	Wgt	Price Each
10B 1500	<b>G 4887 SH RH</b>	<b>Right Hand Seat</b>	White	118 Lbs	\$ 464.88
10B 1550	<b>G 4887 SH RH</b>	<b>Right Hand Seat</b>	Linen	118 Lbs	464.88
10B 1600	<b>G 4887 SH LH</b>	<b>Left Hand Seat</b>	White	118 Lbs	\$ 464.88
10B 1650	<b>G 4887 SH LH</b>	<b>Left Hand Seat</b>	Linen	118 Lbs	464.88

Continued On Next Page

**AQUARIUS  
BATHWARE**

**GELCOAT TUB & SHOWERS**

\*Price Change

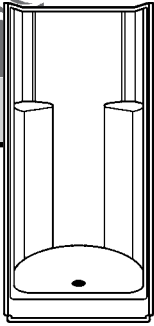

## GELCOAT STANDARD 36" ONE PIECE SHOWER

STANDARD GELCOAT CENTER DRAIN MODEL WITH TWO MOLDED SOAP LEDGES.

LENGTH: 36" WIDTH: 36" HEIGHT: 77.5" SHOWER BYPASS ENCLOSURE: UP TO 32.125" W X 71" H

SSC No.	Manuf. No.	Color	Wgt	Price Each
10B 1700	<b>G 3679 SH</b>	Center Drain	White	105 Lbs \$ 444.35
10B 1750	<b>G 3679 SH</b>	Center Drain	Linen	105 Lbs 444.35

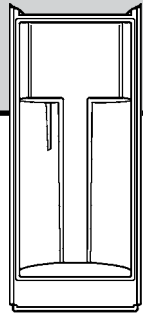

## GELCOAT STANDARD 32" ONE PIECE SHOWER

STANDARD GELCOAT CENTER DRAIN MODEL WITH TWO MOLDED SOAP LEDGES.

SSC No.	Manuf. No.	Color	Wgt	Price Each
10B 1800	<b>G 3280 SH</b>	Center Drain	White	95 Lbs \$ 479.82 *
10B 1850	<b>G 3280 SH</b>	Center Drain	Linen	95 Lbs 431.28

For More Information On These Products Or On Products Not Listed,  
Call *Salina Supply Company* At (785) 823-2221

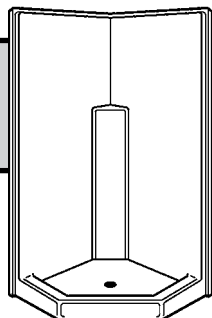

## GELCOAT STANDARD 38" ONE PIECE CORNER SHOWER

STANDARD GELCOAT CENTER DRAIN MODEL.

LENGTH: 39.5" WIDTH: 39.5" HEIGHT: 78.5" SHOWER BYPASS ENCLOSURE: 18.325" X 24" X 18.325" X 68" H

SSC No.	Manuf. No.	Color	Wgt	Price Each
10B 1900	<b>G 3892 NA</b>	Center Drain	White	125 Lbs \$ 591.84 *



Note: All Prices On This Page Have Changed

**COMPRESSION MOLDED FIBERGLASS**  
 • FOR DURABILITY & LONG LIFE • UNIFORM THICKNESS  
 • SMOOTH HIGH GLOSS, ABRASION RESISTANT FINISH  
 • NO MAINTENANCE • EASY TO CLEAN  
 • SEALED SEAMS & EDGES • BUILDING & FIRE CODE APPROVED  
 • FACTORY INSTALLED PRESSURE SENSITIVE TAPE  
 • KITS WITH CAULK, ADHESIVE & COMPLETE INSTRUCTIONS

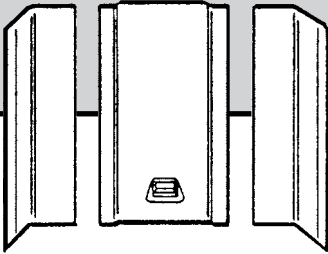

### 3 PIECE TUB WALL KIT

COMPRESSION MOLDED FIBERGLASS • FITS WALL AREA 30" X 60" OR LESS & 58" HIGH

SSC No.	Manuf. No.	Color	Maximum Wall Area	Height	Wgt	Price Each
10D 8960	<b>RM-58</b>	White	30" x 60"	58"	51 Lbs	\$ 464.99
10D 8961	<b>RM-58</b>	Bone	30" x 60"	58"	51 Lbs	464.99

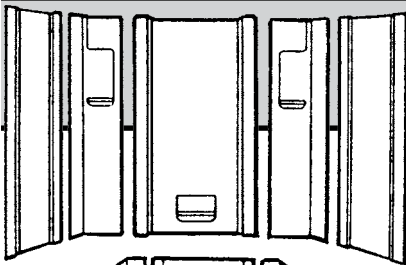

### 5 PIECE TUB WALL KIT

COMPRESSION MOLDED FIBERGLASS • FITS AREA 56" - 62" WIDE X 29" - 32" DEEP & 58" HIGH

SSC No.	Manuf. No.	Color	Maximum Wall Area	Height	Wgt	Price Each
10D 8980	<b>TW-32</b>	White	56" - 62" x 29" - 32"	58"	58 Lbs	\$ 521.24
10D 8985	<b>TW-32</b>	Bone	56" - 62" x 29" - 32"	58"	58 Lbs	521.24

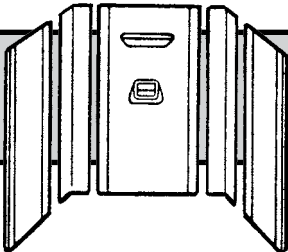

### 5 PIECE SHOWER WALL KIT

COMPRESSION MOLDED FIBERGLASS • FITS AREA 30" - 36" WIDE X 30" - 3" DEEP & 70" HIGH

SSC No.	Manuf. No.	Color	Maximum Wall Area	Height	Wgt	Price Each
10D 9000	<b>SW-7036</b>	White	30" - 36" x 30" - 36"	70"	50 Lbs	\$ 598.27

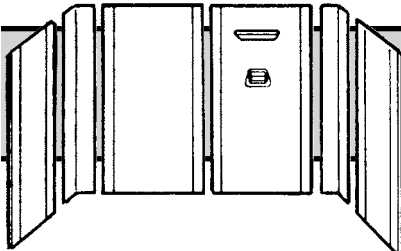

### 5 PIECE SHOWER WALL KIT

COMPRESSION MOLDED FIBERGLASS • FITS AREA 36" - 60" WIDE X 30" - 36" DEEP & 70" HIGH

SSC No.	Manuf. No.	Color	Maximum Wall Area	Height	Wgt	Price Each
10D 9010	<b>SW-7060</b>	White	36" - 60" x 30" - 36"	70"	65 Lbs	\$ 722.42

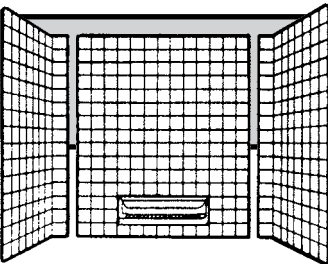

### SWANTILE 3 PIECE TUB WALL KIT

COMPRESSION MOLDED FIBERGLASS • FITS WALL AREA 30" X 60" OR LESS & 58" HIGH

**SWANTILE**  
 • FEEL & APPEARANCE OF EXPENSIVE CUSTOM DESIGNED CERAMIC TILE

SSC No.	Manuf. No.	Color	Maximum Wall Area	Height	Wgt	Price Each
10D 8965	<b>TI-3</b>	White	30" x 60"	58"	60 Lbs	\$ 548.60
10D 8970	<b>TI-3</b>	Bone	30" x 60"	58"	60 Lbs	589.82

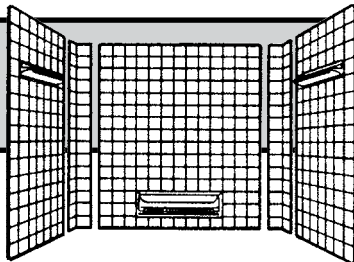

### SWANTILE 5 PIECE TUB WALL KIT

COMPRESSION MOLDED FIBERGLASS • FITS AREA 53" - 60" WIDE X 29" - 32" DEEP & 58" HIGH

SSC No.	Manuf. No.	Color	Maximum Wall Area	Height	Wgt	Price Each
10D 8975	<b>TI-5</b>	Bone	53" - 60" x 29" - 32"	58"	70 Lbs	\$ 648.77





Note: All Prices On This Page Have Changed

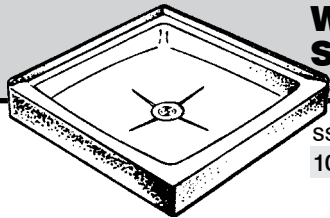

## WHITE MOLDED FIBERGLASS SINGLE THRESHOLD SHOWER FLOOR

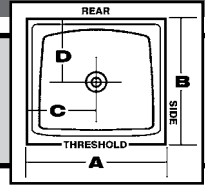

SSC No.	Manuf. No.	Actual Size		Roughing Dimensions				Lbs	Price Each
		A	B	A	B	C	D		
10E 0510	<b>R-3232</b>	31 <sup>7</sup> / <sub>8</sub> "	31 <sup>7</sup> / <sub>8</sub> "	32 <sup>1</sup> / <sub>4</sub> "	32 <sup>1</sup> / <sub>16</sub> "	16 <sup>1</sup> / <sub>8</sub> "	16 <sup>1</sup> / <sub>8</sub> "	50	\$ 174.32

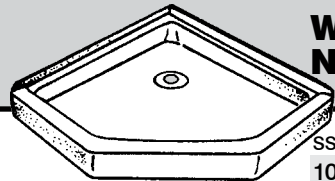

## WHITE MOLDED FIBERGLASS NEO CORNER SHOWER FLOOR

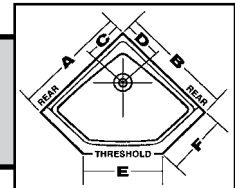

SSC No.	Manuf. No.	Actual Size		Roughing Dimensions				Lbs	Price Each
		A	B	A & B	C & D	E	F		
10E 1610	<b>R-38NEO</b>	37 <sup>13</sup> / <sub>16</sub> "	37 <sup>13</sup> / <sub>16</sub> "	38"	12 <sup>13</sup> / <sub>16</sub> "	25 <sup>3</sup> / <sub>8</sub> "	20 <sup>1</sup> / <sub>16</sub> "	65	\$ 236.75

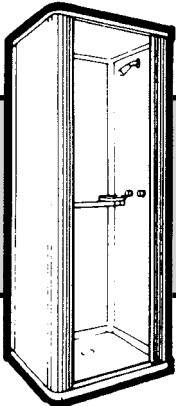

## 32" FIBERGLASS FREE STANDING SHOWER

**CABINET KIT:** • 1 BACK PANEL & 2 SIDE PANELS • ALUMINUM JAMBS & TOP FRAME  
 • 2 CORNER MOLDINGS • NON-SKID FLOOR W/ DRAIN • TOWEL BAR • 2 SOAP DISHES  
 • CURTAIN & ROD • ALL HARDWARE NEEDED FOR ASSEMBLY • INSTRUCTIONS  
**OPTIONAL BASE EXTENSION KIT TO ALLOW FOR ABOVE THE FLOOR DRAINAGE**  
**EXTENSION KIT:** • 4 PIECE INTER-LOCKING FRAME • PRE-DRILLED STYROFOAM SUB-BASE  
 • DRAIN PIPE ASSEMBLY • INSTALLATION INSTRUCTIONS

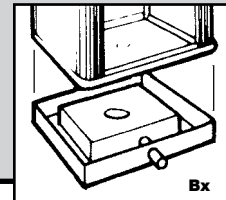

SSC No.	Manuf. No.	Size	Type Base	Wgt	Price Each
10E 4700	<b>FSC-32</b>	32" W x 32" D x 73" H	Standard Base	53 Lbs	\$ 418.86
10E 4730	<b>BX-32</b>	Base Extension Kit For FSC-32		8 Lbs	66.61

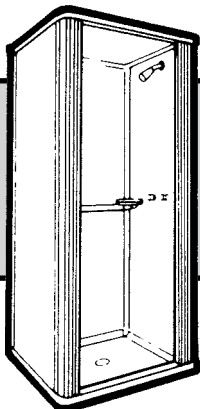

## 36" FIBERGLASS FREE STANDING SHOWER

**CABINET KIT:** • 1 BACK PANEL & 2 SIDE PANELS • ALUMINUM JAMBS & TOP FRAME  
 • 2 CORNER MOLDINGS • NON-SKID FLOOR W/ DRAIN • TOWEL BAR • 2 SOAP DISHES  
 • CURTAIN & ROD • ALL HARDWARE NEEDED FOR ASSEMBLY • INSTRUCTIONS  
**OPTIONAL BASE EXTENSION KIT TO ALLOW FOR ABOVE THE FLOOR DRAINAGE**  
**EXTENSION KIT:** • 4 PIECE INTER-LOCKING FRAME • PRE-DRILLED STYROFOAM SUB-BASE  
 • DRAIN PIPE ASSEMBLY • INSTALLATION INSTRUCTIONS

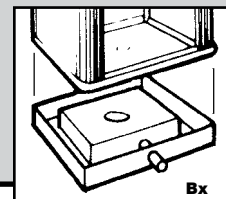

SSC No.	Manuf. No.	SIZE	TYPE BASE	Wgt	Price Each
10E 4760	<b>FSC-36</b>	36" W x 36" D x 73" H	Standard Base	61 Lbs	\$ 504.06
10E 4790	<b>BX-36</b>	Base Extension Kit For FSC-36		10 Lbs	75.65

For More Information On These Products Or On Products Not Listed,  
 Call *Salina Supply Company* At (785) 823-2221



Note: All Prices On This Page Have Changed

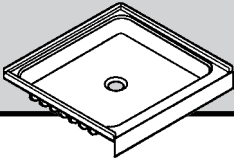

## ENSEMBLE™ 36" VIKRELL SHOWER RECEPTORS

WHITE • COMPRESSION MOLDED VIKRELL™ • PEBBLED BOTTOM SURFACE • DURABLE HIGH GLOSS FINISH  
10 YEAR CONSUMER OR 3 YEAR COMMERCIAL WARRANTY

SSC No.	Manuf. No.	Model	Unit Finished Dimensions	Roughing In Dimensions Including Nail Flange	Wgt Lbs	Price Each
10E 1110	<b>72101100</b>	<b>36"</b>	36" x 34" x 4 1/2"	36" x 34" x 5 1/2"	58	\$ 201.83

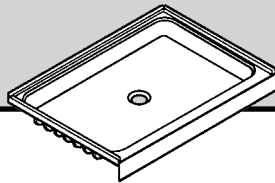

## ENSEMBLE™ 48" VIKRELL SHOWER RECEPTORS

WHITE • COMPRESSION MOLDED VIKRELL™ • PEBBLED BOTTOM SURFACE • DURABLE HIGH GLOSS FINISH  
10 YEAR CONSUMER OR 3 YEAR COMMERCIAL WARRANTY

SSC No.	Manuf. No.	Model	Unit Finished Dimensions	Roughing In Dimensions Including Nail Flange	Wgt Lbs	Price Each
10E 1810	<b>72121100</b>	<b>48"</b>	48" x 34" x 4 1/2"	48" x 34" x 5 1/2"	70	\$ 178.63

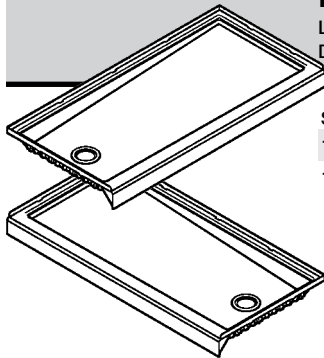

## ENSEMBLE™ 60" VIKRELL SHOWER RECEPTORS

LEFT OR RIGHT HAND MODELS • WHITE • COMPRESSION MOLDED VIKRELL™ • PEBBLED BOTTOM SURFACE  
DURABLE HIGH GLOSS FINISH • 10 YEAR CONSUMER OR 3 YEAR COMMERCIAL WARRANTY

SSC No.	Manuf. No.	Model	Unit Finished Dimensions	Roughing In Dimensions Including Nail Flange	Wgt Lbs	Price Each
10E 2000	<b>72141120</b>	<b>RH</b>	60" x 30" x 4"	60" x 30" x 5"	75	\$ 245.09
10E 2500	<b>72141110</b>	<b>LH</b>	60" x 30" x 4"	60" x 30" x 5"	75	245.09

For More Information On These Products Or On Products Not Listed,  
Call *Salina Supply Company* At (785) 823-2221

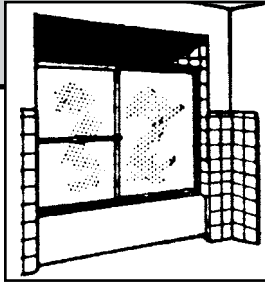
**ALUMAX HOWMET**IMPORTANT NOTE! OPENED SHOWER DOOR CARTONS &  
SPECIAL ORDER SHOWER DOORS ARE NON-RETURNABLE**SLIDING TWO PANEL TUB ENCLOSURES**

TEMPERED GLASS • BRITE-DIP ANODIZED ALUMINUM FINISH

SSC No.	Manuf. No.	Size		Wgt	Price Each
10G 3000	<b>640</b>	56 <sup>3</sup> / <sub>4</sub> " x 55"	For 6087		\$ 243.08
10G 3200	<b>640</b>	58 <sup>1</sup> / <sub>2</sub> " x 58 <sup>1</sup> / <sub>2</sub> "	For 760		255.47
10G 5600	<b>640</b>	60" x 58 <sup>1</sup> / <sub>2</sub> "		78 Lbs	268.46

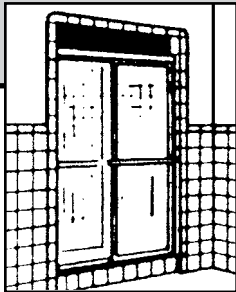
**SLIDING SHOWER ENTRANCES**

TEMPERED GLASS • BRITE-DIP ANODIZED ALUMINUM FINISH

SSC No.	Manuf. No.	Size		Wgt	Price Each
10G 3100	<b>650</b>	44 <sup>3</sup> / <sub>4</sub> " x 68"	For 4887		\$ 264.13
10G 3300	<b>650</b>	56" x 65 <sup>1</sup> / <sub>2</sub> "	For 6077		303.10
10G 5900	<b>650</b>	56 <sup>3</sup> / <sub>4</sub> " x 68"	For 7213	78 Lbs	283.40
10G 5970	<b>650</b>	43" x 66"	For OC-SS-48	75 Lbs	283.40
10G 6110	<b>650</b>	55" x 68 <sup>1</sup> / <sub>8</sub> "	For OC-SS-60	68 Lbs	331.98

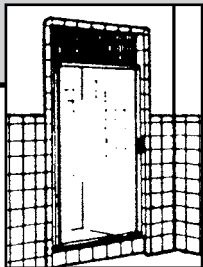
**PIVOT SHOWER DOORS**

TEMPERED GLASS • BRITE-DIP ANODIZED ALUMINUM FINISH

SSC No.	Manuf. No.	Size	Glass Size	Wgt	Price Each
10G 6130	<b>738-24</b>	24" x 64 <sup>1</sup> / <sub>2</sub> "	23" To 25"	30 Lbs	\$ 181.86
10G 6200	<b>738-26</b>	26" x 64 <sup>1</sup> / <sub>2</sub> "	25" To 27"		190.52
10G 6300	<b>738-28</b>	28" x 64 <sup>1</sup> / <sub>2</sub> "	27" To 29"	33 Lbs	190.52
10G 6400	<b>738-30</b>	30" x 64 <sup>1</sup> / <sub>2</sub> "	29" To 31" (OC-32)	38 Lbs	190.52
10G 6500	<b>738-32</b>	32" x 64 <sup>1</sup> / <sub>2</sub> "	31" To 33"	38 Lbs	203.51
10G 6600	<b>738-34</b>	34" x 64 <sup>1</sup> / <sub>2</sub> "	33" To 35" (OC-36)	43 Lbs	190.28

For More Information On These Products Or On Products Not Listed,  
Call *Salina Supply Company* At (785) 823-2221