



* Price Change
** New Product



1400 FUTURA CHROME ACCESSORIES

PROJECTING PARTS DIE CAST FROM HIGHEST QUALITY VIRGIN ZINC ALLOY (ZAMAK). ACCESSORIES MEET ASTM STANDARD B-86. HIGHLY POLISHED. PLATED WITH LAYER OF BRIGHT COPPER & DUPLEX LAYERS OF NICKEL FOR DURABILITY, CORROSION RESISTANCE & BRIGHTNESS. OUTER CHROMIUM LAYER PROVIDES A BRIGHT APPEARANCE, PREVENTS NICKEL OXIDATION & OFFERS ABRASION RESISTANCE.

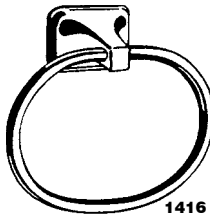
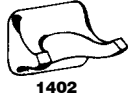
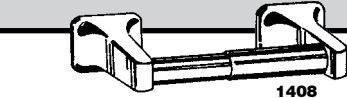

SSC No.	Manuf No.	Description	Price Each
---------	-----------	-------------	------------

FUTURA CHROME SOAP HOLDERS

10J 3210	F1406	Soap Holder	\$ 6.80
----------	-------	-------------	---------

FUTURA CHROME TOOTHBRUSH & TUMBLER HOLDER

10J 3910	F1405		\$ 6.80
----------	-------	--	---------

FUTURA CHROME PAPER HOLDERS

10J 4810	F1408C	Paper Holder With Chrome Roller	\$ 10.73
10J 4910	F1408B	Paper Holder With Plastic Roller	8.71
10J 5210	EROLLP	Chrome Roller For 1408 Paper Holder	1.62

FUTURA CHROME ROBE HOOKS

10J 5610	F1401	Single Hook	1 ⁵ / ₈ " Projection	\$ 3.80
10J 5710	F1402	Double Hook	1 ⁵ / ₈ " Projection	4.25

FUTURA CHROME TOWEL RING

10J 5910	1416	Chrome Plated Brass Ring		\$ 9.07
----------	------	--------------------------	--	---------

FUTURA CHROME SQUARE TOWEL BAR SET

10J 6310	1418	18" Long	3/4" Square	\$ 10.77
10J 6410	1424	24" Long	3/4" Square	10.69
10J 6510	1430	30" Long	3/4" Square	12.76
10J 6610	1436	36" Long	3/4" Square	17.26

INSTALLATION:
FURNISHED WITH HEAVY GAUGE
STEEL PLATES. SCREW SLOTS
ALLOW LATERAL ADJUSTMENT. THE
UNIQUE OVAL DESIGN PERMITS
EASY ADJUSTMENT OF ACCESSORY
EVEN AFTER MOUNTING.

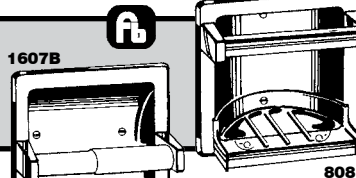
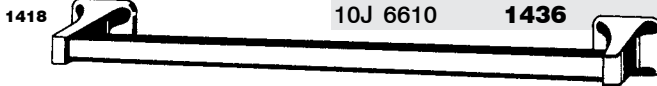

INSTALLATION:
ALL RECESS ITEMS ARE FURNISHED
WITH WOOD SCREWS FOR STANDARD
INSTALLATIONS. USE RECESS WALL
CLAMP FOR CONVENTIONAL TYPE
INSTALLATIONS. MACHINE SCREWS
SECURE CLAMP TO BACK SIDE OF
FRONT WALL.

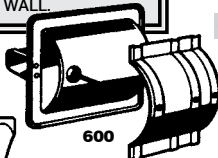

CHROME RECESSED ACCESSORIES

THE CHROME PLATED BRASS SHELLS ARE STAMPED FROM SPECIAL ALLOY BRASS STRIP. HIGHLY POLISHED & ARE PLATED WITH COPPER, DOUBLE NICKEL & CHROME COATING TO MEET COMMERCIAL & GOVERNMENT STANDARDS. GRAB BAR TUBING IS OF SEAMLESS CHROME PLATED BRASS. THE REMOVABLE SOAP TRAYS ARE TOUGH STYRENE COPOLYMER.

SSC No.	Manuf No.	Overall Size	Wall Opening	Price Each
---------	-----------	--------------	--------------	------------

CHROME RECESSED SOAP & BAR

10J 4610	858	6 ¹ / ₄ " x 5 ¹ / ₄ "	5 ¹ / ₄ " x 4 ¹ / ₄ " x 1 ¹ / ₄ "	\$ 15.23
10J 3810				Replacement Soap Dish For 808 Soap & Bar 1.42 **

CHROME RECESSED PAPER HOLDER WITH PLASTIC ROLLER

10J 5010	1607B	6 ¹ / ₄ " x 6 ¹ / ₄ "	5 ¹ / ₄ " x 5 ¹ / ₄ " x 2"	\$ 19.08
----------	-------	---	--	----------

CHROME RECESSED WALL CLAMP

10J 3110	600R	For Chrome & Stainless Steel		\$ 3.33
----------	------	------------------------------	--	---------

WATTS® BASIN LAVATORY LEG FOR CHINA BASIN

28" POLISHED STAINLESS STEEL LEG WITH 2" CHROME PLATED STEEL COVER FLANGE.

SSC No.	Manuf No.	Length	Wgt.	Price Each
10J 0110	650 003	28" LONG	2 Lbs	\$ 10.98 **

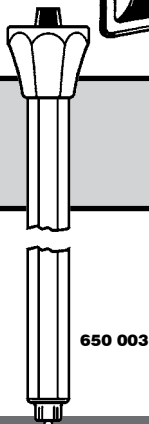

Continued On Next Page

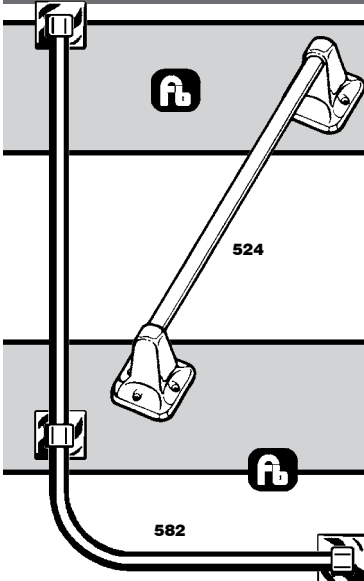

SAFETY FIRST CHROME STRAIGHT GRAB BARS

HEAVY DUTY. SAFETY ENGINEERED TO WITHSTAND 300 LB PULL WHEN SECURELY INSTALLED. POSTS ARE FINEST QUALITY VIRGIN ZINC ALLOY (ZAMAK) WITH COPPER, NICKEL & CHROME PLATING FINISH OVER HIGHLY POLISHED SURFACE. BAR IS 7/8" X .045 BRASS TUBING FINISHED WITH COPPER, NICKEL & CHROME PLATING OVER HIGHLY POLISHED SURFACE. BAR SET SCREW 1/4" X 20" X 1 1/2" CADMIUM STEEL. MOUNTING SCREWS 2" X 8" STAINLESS STEEL.

SSC No.	Manuf No.	Bar Length	Base Dimension	Wgt	Price Each
10J 1110	S1F516PC	16"	2 1/4" x 2 3/8"	1.5 Lbs	\$22.90 *
10J 1210	524-SS	24"	2 1/4" x 2 3/8"	2.0 Lbs	27.30 *

SAFETY FIRST CHROME ANGLE GRAB BAR

HEAVY DUTY. SAFETY ENGINEERED TO WITHSTAND 300 LB PULL WHEN SECURELY INSTALLED. POSTS ARE FINEST QUALITY VIRGIN ZINC ALLOY (ZAMAK) WITH COPPER, NICKEL & CHROME PLATING FINISH OVER HIGHLY POLISHED SURFACE. BAR IS 7/8" X .045 BRASS TUBING FINISHED WITH COPPER, NICKEL & CHROME PLATING OVER HIGHLY POLISHED SURFACE. BAR SET SCREW 1/4" X 20" X 1 1/2" CADMIUM STEEL. MOUNTING SCREWS 2" X 8" STAINLESS STEEL.

SSC No.	Manuf No.	Size	Wgt	Price Each
10J 1410	582	16" x 32" Angle Bar With Center	3.6 Lbs	\$ 73.28

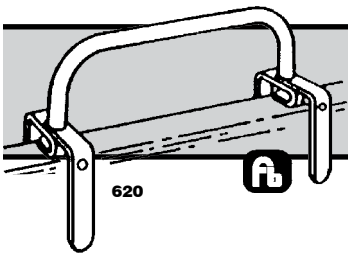

SAFETY FIRST TUB SAFETY BAR

1" NON-CORROSIVE ANODIZED ALUMINUM, NON-SLIP BAR. ADJUSTABLE 1 1/4" SUPPORT BRACKETS WITH PROTECTIVE PADS TO FIT MOST STANDARD TUB CONTOURS. INSTALLS WITH WRENCH-SCREWDRIVER PROVIDED. ALL FASTENERS INCLUDED. PORTABLE - CAN BE REMOVED & REINSTALLED ON OTHER TUBS.

SSC No.	Manuf No.	Size	Wgt	Price Each
10K 3100	D590/620	7 1/2" H x 18" W	6.0 Lbs	\$ 37.67



•EMERGENCY FIXTURES •EXPRESS® LAVATORY SYSTEMS •SHOWER GUIDE •WASHROOM ACCESSORIES
•ADA WASHROOM PRODUCT GUIDE •LABORATORY FITTINGS •PATIENT CARE •INSTALLATION & TECHNICAL DATA

For More Information On These Products Or On Products Not Listed,
Call *Salina Supply Company* At (785) 823-2221

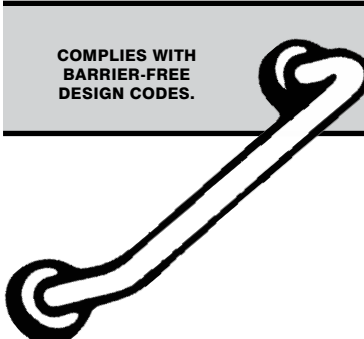

COMPLIES WITH BARRIER-FREE DESIGN CODES.

Jones Stephens Corp. GRAB BARS WITH CONCEALED MOUNTING

PROVIDES 1 1/2" CLEARANCE FROM WALL & CAN SUPPORT LOADS IN EXCESS OF 900 LBS WHEN PROPERLY INSTALLED. TYPE-304 STAINLESS STEEL. 18 GA. TUBING WITH SATIN FINISH. 22 GA. 3 1/4" COVER SNAPS OVER 1/8" x 3 1/8" MNTG FLANGE.

SSC No.	Manuf No.	Bar Diameter	Length	Wgt.	Price Each
10J 6900	G13-112	1 1/2"	12"	2.0 Lbs	\$ 22.40
10J 6990	G13-118	1 1/2"	18"	3.0 Lbs	26.63
10J 7000	G13-124	1 1/2"	24"	3.0 Lbs	30.49
10J 7020	G13-136	1 1/2"	36"	3.0 Lbs	40.52
10J 7030	G13-142	1 1/2"	42"	3.0 Lbs	43.32
10J 7040	G13-148	1 1/2"	48"	3.1 Lbs	46.35



*Price Change

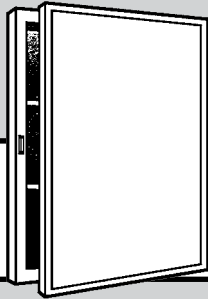

SURFACE MOUNTED MEDICINE CABINET

BOBRICK

ALL STEEL CABINET & TWO FIXED SHELVES WITH BAKED WHITE ENAMEL FINISH. NO. 1 QUALITY MIRROR HAS 1/8" ELECTROLYTICALLY COPPER PLATED GLASS. DOOR HAS ENAMELED STEEL PIANO HINGE & MAGNETIC CATCH. 69" AVERAGE MOUNTING HEIGHT & 60" BARRIER FREE MOUNTING HEIGHT.

SSC No.	Manuf No.	Overall Size	Wgt	Price Each
10H 0110	B-297	14 ¹ / ₈ " W x 20 ¹ / ₄ " H x 3 ³ / ₄ " D	11.4 Lbs	\$ 130.50

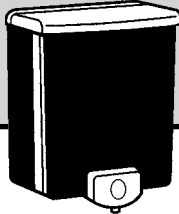

SURFACE MOUNTED SOAP DISPENSER

BOBRICK

BLACK & GREY. PUSH-IN VALVE DIRECTS OPERATING PRESSURE TOWARD WALL. CORROSION-RESISTANT, SELF-CLEANING VALVE DISPENSES WIDE RANGE OF LIQUID SOAPS, LOTIONS & SYNTHETIC DETERGENTS. VANDAL-RESISTANT LID HAS UNIQUE KEYLESS LOCKING DEVICE. LID PIVOTS UP AFTER LOCK IS DISENGAGED FOR EASY TOP FILLING. LARGE CAPACITY, TRANSLUCENT CONTAINER PROVIDES VISIBLE SOAP LEVEL. CONCEALED WALL FASTENING. REMOVABLE FROM WALL FOR CLEANING. 40 FLUID OUNCE CAPACITY.

SSC No.	Manuf No.	Overall Size	Wgt	Price Each
10H 1000	B-40	5 ¹³ / ₁₆ " W x 6 ⁷ / ₈ " H x 3 ³ / ₁₆ " Wall To Push Button	1.2 Lbs	\$ 22.28

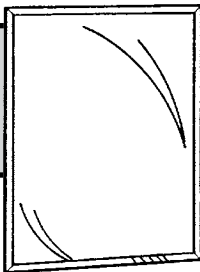

STAINLESS STEEL CHANNEL FRAME MIRROR

BOBRICK

ONE PIECE FRAME BRIGHT POLISHED FINISH & MITERED CORNERS. PHILLIPS HEAD FRAME SCREWS FOR EASY MIRROR REPLACEMENT. WITH QUALITY ELECTROLYTICALLY COPPER PLATED 1/4" FLOAT/PLATE GLASS MIRROR; GUARANTEED 10 YEARS AGAINST SILVER SPOILAGE. MIRROR EDGES & GALVANIZED STEEL BACK PROTECTED BY SHOCK ABSORBING MATERIAL. CONCEALED WALL HANGER. LOCKS IN PLACE WITH 2 THEFT RESISTANT SCREWS.

SSC No.	Manuf No.	Overall Size	Frame Size	Wgt	Price Each
10H 1220	B-165 1836	18" x 36" x 1/2"	1/2" x 1/2" x 1/2"	10 Lbs	\$ 85.50

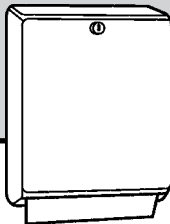

SURFACE MOUNTED PAPER TOWEL DISPENSER

BOBRICK

DISPENSES 400 C-FOLD OR 525 MULTIFOLD TOWELS WITHOUT ADJUSTMENT OR ADAPTERS. CABINET TYPE DISPENSER IS TYPE-304 STAINLESS STEEL WITH SATIN FINISH. DOOR HAS TUMBLER LOCK & PIANO-HINGE. CABINET SLOTS INDICATE REFILL TIME.

SSC No.	Manuf No.	Overall Size	Wgt	Price Each
10H 1500	B-262	10 ³ / ₄ " W x 14 ³ / ₄ " H x 4" D	4.8 Lbs	\$ 50.73

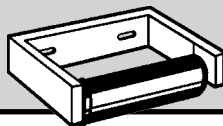

SURFACE MOUNTED TOILET TISSUE DISPENSER

BOBRICK

WITH CONTROLLED DELIVERY. HEAVY-DUTY CAST ALUMINUM WITH SATIN FINISH. HIGH-IMPACT PLASTIC SPINDLES HAVE CONCEALED LOCKING DEVICE. THEFT RESISTANT. HOLDS ONE ROLL UP TO 6" DIAMETER (2000 SHEETS).

SSC No.	Manuf No.	Size	Wgt	Price Each
10H 2000	B-273	12 ¹ / ₂ " W & Projects 4 ⁷ / ₈ " From Wall	1.0 Lbs	\$ 22.16 *

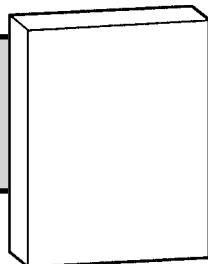

SURFACE MOUNTED WASTE RECEPTACLE

BOBRICK

TYPE-304 STAINLESS STEEL WITH SATIN FINISH. BOTTOM EDGES HEMMED FOR MAXIMUM SAFETY. FURNISHED WITH HEAVY-GAUGE VINYL LINER. LINER IS REMOVABLE FOR SERVICING. 6.4 GALLON CAPACITY.

SSC No.	Manuf No.	Size	Wgt	Price Each
10H 2500	B-279	14" W x 18" H x 6" D	10 Lbs	Call For Price

Continued On Next Page



*Price Change

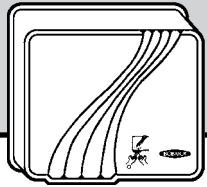

COMPACDRYER® SURFACE MOUNTED HAND DRYER BOBRICK

FOR BUDGET INSTALLATIONS. NO PROJECTING NOZZLE OR PUSH BUTTON. CONCEALED AIR-INTAKE GRILLE. QUIET OPERATION. ELECTRONIC SENSOR FOR NO-TOUCH OPERATION. AUTOMATIC CYCLE SHUT-OFF SAVES ENERGY & OPERATING COSTS. ONE-PIECE WHITE MOLDED PLASTIC COVER HAS LED ON/OFF INDICATOR LIGHT & UNIVERSAL OPERATING SYMBOLS. SOLID-STATE ELECTRONICS. 115V AC, 15 AMP, 1725 WATTS, 60 HZ, SINGLE PHASE, C-UL LISTED. ONE-YEAR WARRANTY.

SSC No.	Manuf No.	Overall Size	Wgt	
10H3000	B-710	10 ³ / ₄ " W x 10 ¹ / ₄ " H x 5 ¹ / ₂ " D	8.1 Lbs	Call For Price



LAVATORY-MOUNTED SOAP DISPENSER BOBRICK

CONTURA SERIES. CORROSION-RESISTANT VALVE DISPENSES LIQUID SOAPS, LOTIONS & DETERGENTS. SPOUT ROTATES 360° WITHOUT DAMAGE TO THE VALVE MECHANISM. COVER LOCKS TO BODY WITH CONCEALED LOCKING MECHANISM, OPENED ONLY WITH SPECIAL KEY PROVIDED. PISTON, SPOUT & SUPPLY TUBE ASSEMBLY REMOVABLE AFTER UNLOCKING FOR CONVENIENT TOP FILLING & MAINTENANCE. TYPE-304 STAINLESS STEEL WITH BRIGHT POLISHED FINISH DISPENSER. 34 OUNCE CAPACITY CONTAINER.

SSC No.	Manuf No.	Container Size	Wgt	Price Each
10H 3500	B-822	9 ⁹ / ₁₆ " H x 3 ⁵ / ₁₆ " Diameter	1.2 Lbs	\$ 44.56

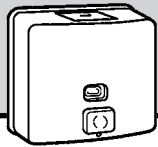

SURFACE MOUNTED SOAP DISPENSER BOBRICK

CONTURA SERIES. CORROSION-RESISTANT VALVE DISPENSES LIQUID SOAPS, LOTIONS & DETERGENTS. CONTAINER IS DRAWN, 20 GAUGE, ONE PIECE CONSTRUCTION. WITH UNBREAKABLE REFILL WINDOW. WITH CONCEALED WALL FASTENING. THE HINGED FILLER-TOP REQUIRES SPECIAL KEY TO OPEN. VANDAL RESISTANT. 40 FLUID OUNCE CAPACITY.

SSC No.	Manuf No.	Size	Wgt	Price Each
10H 4000	B-4112	7" W x 6 ¹ / ₈ " H x 3 ⁵ / ₁₆ " Wall To Push Button	2.1 Lbs	\$ 70.35

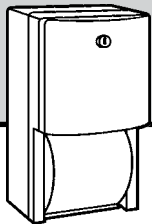

MULTI-ROLL TOILET TISSUE DISPENSER BOBRICK

SURFACE MOUNTED, TYPE-304 STAINLESS STEEL WITH SATIN FINISH. PLATED STEEL DISPENSING MECHANISM HOLDS TWO ROLLS UP TO 5¹/₄" DIAMETER (1800 SHEETS). EXTRA ROLL AUTOMATICALLY DROPS IN PLACE WHEN BOTTOM ROLL IS DEPLETED. THEFT-RESISTANT, HEAVY-DUTY SPINDLES HAVE 1/8" WALL THICKNESS. DOOR HAS FLAT FACE WITH PROTRUDING TUMBLER LOCK.

SSC No.	Manuf No.	Size	Wgt	Price Each
10H 4500	B-2888	6 ¹ / ₁₆ " W x 11" H x 5 ¹⁵ / ₁₆ " D	7.5 Lbs	\$ 68.09 *

For More Information On These Products Or On Products Not Listed,
Call *Salina Supply Company* At (785) 823-2221