

RIDGID PIPE WRENCHES

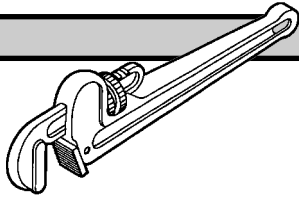

HEAVY DUTY STRAIGHT PIPE WRENCH

SSC No.	Manuf. No.		Size	Wgt	Price Each
54A 0050	3100	6	6"	0.50 lbs	\$ 21.31
54A 0100	3105	8	8"	0.75 lbs	25.65
54A 0110	31010	10	10"	1.75 lbs	33.79
54A 0120	31015	12	12"	1.75 lbs	39.05
54A 0140	31020	14	14"	3.50 lbs	43.72
54A 0150	31025	18	18"	5.75 lbs	63.13
54A 0160	31030	24	24"	9.75 lbs	100.01
54A 0170	31035	36	36"	19.00 lbs	213.37
54A 0180	31040	48	48"	34.25 lbs	321.70

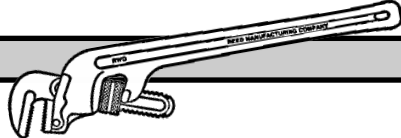

HEAVY DUTY OFFSET PIPE WRENCH

54A 0200	31060	E-10	10"	1.83 lbs	\$ 39.34
54A 0210	31065	E-12	12"	2.75 lbs	45.79
54A 0220	31070	E-14	14"	3.50 lbs	52.32
54A 0230	31075	E-18	18"	5.75 lbs	74.84

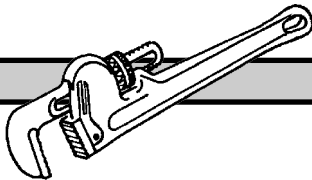

ALUMINUM STRAIGHT PIPE WRENCH

54A 0250	31090	810	10"	1.00 lbs	\$ 53.86
54A 0260	31095	814	14"	2.50 lbs	73.13
54A 0270	31100	818	18"	3.75 lbs	91.20
54A 0280	31105	824	24"	6.00 lbs	145.57
54A 0290	31110	836	36"	11.00 lbs	238.56

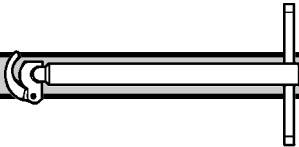

TELESCOPING BASIN WRENCH

54A 0295	31175	1017	3/8" To 1 1/4" Pipe Capacity	2.00 lbs	\$ 48.48
----------	--------------	------	------------------------------	----------	----------



CHROME ADJUSTABLE WRENCH

54A 0300	31185	704	4"	0.12 lbs	\$ 20.21
54A 0305	31190	706	6"	0.25 lbs	21.10
54A 0310	31195	708	8"	0.50 lbs	21.79
54A 0315	86912	760	10"	0.75 lbs	26.15
54A 0320	86917	762	12"	1.50 lbs	37.08
54A 0325	31210	715	15"	3.00 lbs	53.95

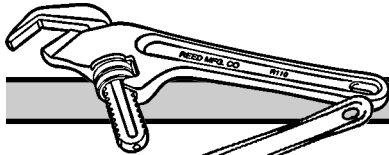

OFFSET HEX WRENCH

54A 0350	31305	E-110	1 1/8" To 2 5/8" Pipe Capacity	1.50 lbs	\$ 47.79
----------	--------------	-------	--------------------------------	----------	----------

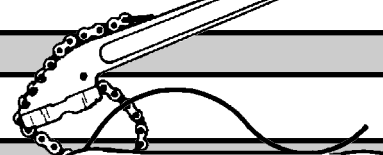

HEAVY DUTY CHAIN WRENCH

54A 0360	31315	C-14	2" Pipe - 18 1/2" Chain	2.75 lbs	\$ 85.17
----------	--------------	------	-------------------------	----------	----------



STRAP WRENCH

54A 0400	31340	2	2" Pipe - 3 1/2" OD - 17" Strap	1.75 lbs	\$ 44.66
----------	--------------	---	---------------------------------	----------	----------

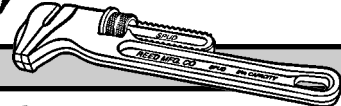

SPUD WRENCH

54A 0490	31400		12"	2.50 lbs	\$ 55.80
----------	--------------	--	-----	----------	----------



HEAVY DUTY OFFSET PIPE WRENCH

54A 2700	31120	14	14"	2.00 lbs	\$ 92.31
54A 2750	31125	18	18"	5.75 lbs	125.57



RAPID GRIP WRENCH

54A 0850	97837	12	12"	3.00 lbs	\$ 44.64
----------	--------------	----	-----	----------	----------

RIDGID PIPE & TUBING CUTTERS • REAMERS

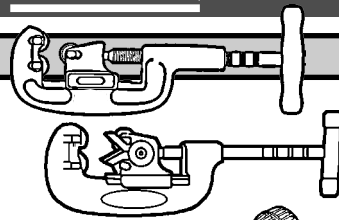

HEAVY-DUTY PIPE CUTTERS

SSC No.	Manuf No.		Pipe Capacity Nom.		Wgt	Price Each
54A 0610	32820	2-A	1/8" to 2"	Single Wheel	7.00 lbs	\$ 207.46
54A 0620	32840	4-S	2" to 4"	Single Wheel	18.00 lbs	539.08
54A 0640	32870	42-A	3/4" to 2"	4 Wheel	6.80 lbs	234.47

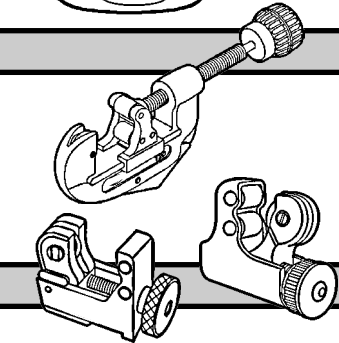

TUBING & CONDUIT CUTTERS

SSC No.	Manuf No.		O.D. Capacity		Wgt	Price Each
54A 0670	32910	10	1/8" to 1"	Fold-Away Reamer	0.80 lbs	\$ 40.60
54A 0675	32920	15	3/16" to 1 1/8"	Fold-Away Reamer	1.30 lbs	46.90
54A 0680	32930	20	5/8" to 2 1/8"	Fold-Away Reamer	1.80 lbs	86.73
54A 0690	32940	30	1" to 3 1/8"		3.50 lbs	134.21

CLOSE QUARTERS TUBING CUTTERS

54A 0700	32975	103	1/8" to 5/8"		0.25 lbs	\$ 19.26
54A 0710	32985	104	3/16" to 15/16"		0.25 lbs	22.52

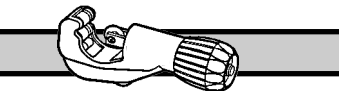

CONSTANT SWING TUBING CUTTER

54A 0720	31622	150	1/8" to 1 1/8"		0.80 lbs	\$ 41.05
----------	--------------	------------	----------------	--	----------	----------

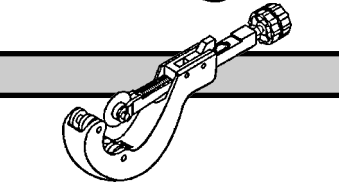

QUICK-ACTING TUBING CUTTERS

54A 0500	31657	154-P	1 1/2" to 4" (Nom Plastic Pipe Size)		3.00 lbs	\$ 170.82
54A 0793	31637	151-P	1/8" to 1 1/4" (Nom Plastic Pipe Size)		0.80 lbs	79.20
54A 0800	36592	153-P	1" to 3" (Nom Plastic Pipe Size)		2.00 lbs	145.36



ENCLOSED FEED CUTTER

54A 0810	33055	205	1/4" to 2 3/8"		1.75 lbs	\$ 105.14
----------	--------------	------------	----------------	--	----------	-----------

For More Information On These Products Or On Products Not Listed,
Call *Salina Supply Company* At (785) 823-2221

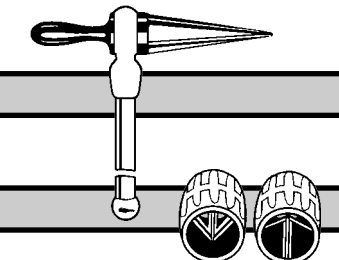

SPIRAL RATCHET PIPE REAMER

54A 0900	34955	2S	1/4" to 2"		7.25 lbs	\$ 313.81
----------	--------------	-----------	------------	--	----------	-----------

INNER-OUTER REAMER FOR PLASTIC WATER TUBE

54A 0910	34965	127	1/4" to 1 1/2"		0.40 lbs	\$ 28.81
----------	--------------	------------	----------------	--	----------	----------

RIDGID PIPE TAP PIPE THREADERS

RIDGID RIGHT HAND PIPE TAP



SSC No.	Manuf No.	Size	Wgt	Price Each
54A 1300	35815 E5112	1/8"	0.20 lbs	\$ 15.97
54A 1310	35820 E5113	1/4"	0.20 lbs	18.26
54A 1320	35825 E5114	3/8"	0.25 lbs	25.23
54A 1330	35830 E5115	1/2"	0.25 lbs	30.45
54A 1340	35835 E5116	3/4"	0.50 lbs	43.81
54A 1350	35840 E5117	1"	1.00 lbs	66.11
54A 1360	35845 E5118	1 1/4"	1.25 lbs	92.16
54A 1370	35850 E5119	1 1/2"	2.00 lbs	123.77
54A 1380	35855 E5120	2"	3.25 lbs	182.48

RIDGID PIPE THREADERS

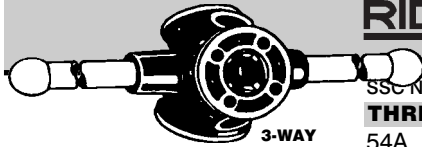

3-WAY



36565 65RC

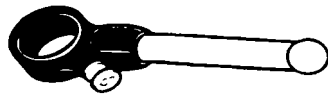

THREADER WITH HANDLE

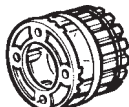

DIE HEAD

SSC No.	Manuf No.	Capacity	Wgt	Price Each
THREE-WAY MANUAL PIPE THREADER				
54A 1700	36515 30A	3/8" to 3/4"	7.00 lbs	\$ 384.10
54A 1740	36540 31A	1/2" to 1"	10.50 lbs	384.10

SSC No.	Manuf No.	Capacity	Wgt	Price Each
RATCHET THREADER WITH CAM TYPE WORK HOLDER THREADS 1" TO 2" WITH 1 SET OF CHASER DIES				
54A 1760	36565 65RC	1" to 2"	27 lbs	\$ 1151.17

SSC No.	Manuf No.	Capacity	Wgt	Price Each
RATCHET THREADER & HANDLE COMPLETE				
54A 2600	38535 0R	1/8" to 1"	4.17 lbs	\$ 148.07
54A 2610	38540 00R	1/8" to 1"	3.52 lbs	93.56
54A 2620	38545 11R	1/8" to 1 1/4"	5.96 lbs	148.07
54A 2630	38550 111R	1/8" to 1 1/4"	4.54 lbs	113.85
54A 2640	38555 12R	1/8" to 2"	5.62 lbs	101.83

SSC No.	Manuf No.	Capacity	Wgt	Price Each
RATCHET THREADER DIE HEADS COMPLETE - RH ALLOY				
54A 2000	36880 00R	1/4"		\$ 95.11
54A 2010	36885 00R	3/8"		95.11
54A 2020	36890 00R	1/2"		95.11
54A 2030	36895 00R	3/4"		95.11
54A 2040	36900 00R	1"		102.11
54A 2110	37035 11R	3/8"		\$ 140.92
54A 2120	37040 11R	1/2"		140.92
54A 2130	37045 11R	3/4"		140.92
54A 2140	37050 11R	1"		154.30
54A 2250	37205 111R	1/4"		\$ 150.00
54A 2260	37210 111R	3/8"		150.00
54A 2270	37215 111R	1/2"		150.00
54A 2280	37220 111R	3/4"		150.00
54A 2290	37225 111R	1"		150.00
54A 2300	37230 111R	1 1/4"		129.46
54A 2430	37390 12R	1/2"		\$ 133.18
54A 2440	37395 12R	3/4"		135.89
54A 2450	37400 12R	1"		172.98
54A 2460	37405 12R	1 1/4"		172.98
54A 2470	37410 12R	1 1/2"		190.68
54A 2480	37415 12R	2"		190.68

RIDGID VISES FLARING TOOLS THREAD CUTTING OILS



RIDGID PORTABLE TRISLAND CHAIN VISE

WITH BUILT-IN FOLDING TOOL TRAY. TOP SCREW CHAIN VISE.

SSC No.	Manuf No.	Capacity	Wgt	Price Each
54A 2860	72037 460	1/8" to 5"	42.5 lbs	\$ 581.67

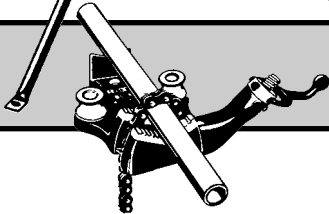

RIDGID TOP SCREW BENCH CHAIN VISE

SSC No.	Manuf No.	Capacity	Wgt	Price Each
54A 2880	40185 BC210	1/8" to 2 1/2"	5.5 lbs	\$ 173.15
54A 2890	40195 BC410	2 1/2" to 4"	13.0 lbs	285.97

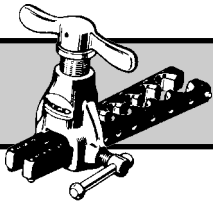

SCREW TYPE

RIDGID FLARING TOOLS

SSC No.	Manuf No.	Size	Wgt	Price Each
SCREW TYPE 1/8" • 3/16" • 1/4" • 5/16" • 3/8" • 7/16" • 1/2" • 5/8" • 3/4"				
54A 3000	36607 458	1/8" to 3/4"	3.25 lbs	\$ 186.19



HAMMER TYPE

SSC No.	Manuf No.	Size	Wgt	Price Each
HAMMER TYPE FLARE TOOL				
54A 3005	41320 E45	1/2"	0.25 lbs	\$ 16.33
54A 3010	41330 E47	3/4"	0.50 lbs	20.58
54A 3020	41335 E52	1"	0.75 lbs	25.92
54A 3030	41345 E63	1 1/2"	1.50 lbs	56.65
54A 3040	41350 E64	2"	2.25 lbs	90.04



RIDGID NU-CLEAR OR DARK THREAD CUTTING OIL

SSC No.	Manuf No.	Size	Wgt	Price Each
NU-CLEAR THREAD CUTTING OIL				
54A 3140	41565	1 Quart	2.30 lbs	\$ 14.44
54A 4500	70835	1 Gallon	4.00 lbs	27.43
54A 3150	41575	5 Gallon	42.0 lbs	123.96

SSC No.	Manuf No.	Size	Wgt	Price Each
DARK THREAD CUTTING OIL				
54A 4490	70830	1 Gallon	4.00 lbs	\$ 25.21
54A 3190	41600	5 Gallon	42.0 lbs	101.38

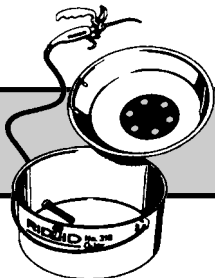

RIDGID OILER

COMES WITH 1 GALLON THREAD CUTTING OIL

SSC No.	Manuf No.	Wgt	Price Each
54A 3200	41650 318 / 72337 418	21.5 lbs	\$ 385.12

RIDGID POWER DRIVE RULE GLASS CUTTER

MISC. STRAPS

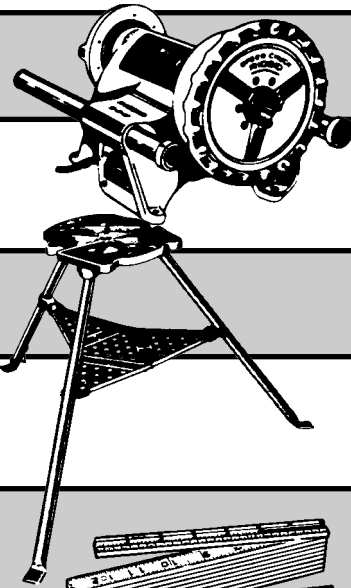

RIDGID 1/2 H.P. POWER DRIVE

HEAVY DUTY REVERSIBLE SWITCH. SPEED CHUCK WITH REPLACEABLE INSERT JAWS. REAR ENTERING DEVICE & HEAVY DUTY SUPPORT BARS. CONVERTS TO THREADING MACHINE WHEN DIE HEAD, 311 CARRIAGE, 360 CUTTER & 340 REAMER ARE ADDED.

SSC No.	Manuf No.	Size	Wgt.	Price Each
54A 3300	41855 300	115 V 38 RPM A.C. or D.C.	96 lbs	\$ 3449.41

RIDGID POWER DRIVE STAND

SSC No.	Manuf No.	Size	Wgt.	Price Each
54A 3500	42360 1206	For 300 Power Drive	31 lbs	\$ 477.98

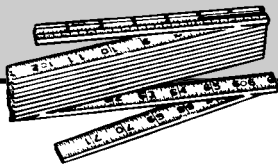

RIDGID FIBERGLASS FOLDING RULE

SSC No.	Manuf No.	Size	Wgt.	Price Each
54A 4700	73370 1619F	6'	3 lbs	\$ 24.49

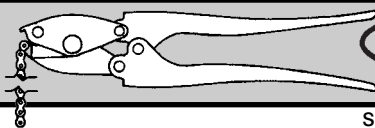

SQUEEZE & POP GAUGE GLASS CUTTER

SSC No.	Manuf No.	Size	Price Each
54C 1540	69012	Thru 3/4" Diameter	\$ 71.04



MISC. STRAPS

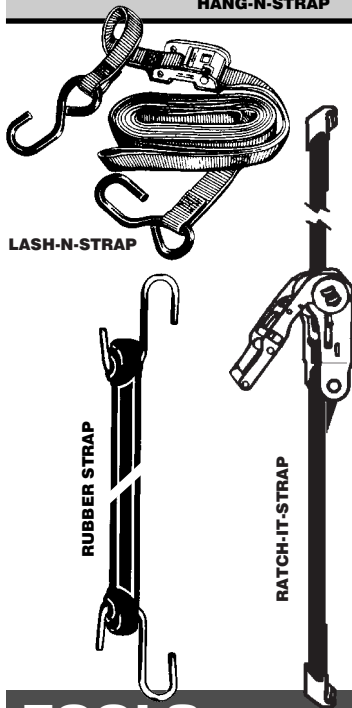

SSC No.	Manuf No.	Size	Wgt.	Price Each
HANG-N-STRAPS				
42A 0300	HS-30/1162486	1" x 31"	Hang-N-Strap	\$ 5.38
42A 0340	HS-60/1162487	1" x 60"	Hang-N-Strap	10.54

SSC No.	Manuf No.	Size	Wgt.	Price Each
LASH-N-STRAP				
42A 0600	HS-144/1161185	1" x 12'	Lash-N-Strap	\$ 33.55



SSC No.	Manuf No.	Size	Wgt.	Price Each
RATCH-IT-STRAP				
42A 0605	HS-192/1160746	192"	Ratch-It-Strap	\$ 47.70

SSC No.	Manuf No.	Size	Wgt.	Price Each
RUBBER STRAPS				
42A 0610	RS-9/1161186	9"	Rubber Strap	.4 lbs \$ 2.13
42A 0630	S20-015	15"	H/D Rubber Strap	.4 lbs 1.53
42A 0640	S20-021	21"	H/D Rubber Strap	.4 lbs 2.28
42A 0650	S20-031	31"	H/D Rubber Strap	.6 lbs 2.36

MIDWEST *Malco* SNIPS HVAC TOOLS

P6716-L  **MIDWEST** *Malco* **FORGED BLADE AVIATION SNIPS**

SSC No.	Manuf No.	Length	Cut	Wgt	Price Each
54E 0210	P6716-L	10"	1 ⁵ / ₁₆ " - Cuts Left	15 oz.	\$ 17.10
54E 0260	P6716-R	10"	1 ⁵ / ₁₆ " - Cuts Right	15 oz.	17.10
54E 0310	P6716-S	10"	1 ¹ / ₂ " - Cuts Straight	15 oz.	17.10

P6716-R  **P6716-S** 

 **M-14** *Malco* **ALUMINUM HANDLED BULLDOG SNIPS**

SSC No.	Manuf No.	Size	Wgt.	Price Per Pair
54E 0176	M-14	3 ¹ / ₂ "	1.80 lbs	\$ 45.44

P6510-L  **MIDWEST** *Malco* **FORGED BLADE OFFSET AVIATION SNIPS**

SSC No.	Manuf No.	Length	Cut	Wgt	Price Each
54E 1560	P6510-L	10"	1 ¹ / ₄ " - Cuts Left	15 oz.	\$ 22.00
54E 1570	P6510-R	10"	1 ¹ / ₄ " - Cuts Rightt	15 oz.	22.00

P6510-R 

 **P6716-A** **MIDWEST** *Malco* **FORGED BLADE LONG CUT AVIATION SNIPS**

SSC No.	Manuf No.	Length	Cut	Wgt	Price Each
54E 2000	P6716-A	11 ¹ / ₂ "	3" - Cuts Straight	16 oz	\$ 28.48

 **FCT-M-C5** **MIDWEST** *Malco* **5" BLADE HAND CRIMPER**

SSC No.	Manuf No.	Length	Wgt	Price Each
54E 1310	FCT-M-C5	8"	16 oz.	\$ 33.20

 **FCT-M-S1** **MIDWEST** *Malco* **3" HAND SEAMER**

SSC No.	Manuf No.	Length	Wgt	Price Each
54E 1410	FCT-M-S1	8 ¹ / ₄ "	1 lb. 8 oz.	\$ 49.90

 **FCT-M-N1** **MIDWEST** *Malco* **31° HAND NOTCHER**

SSC No.	Manuf No.	Length	Notches:	Wgt	Price Each
54E 1360	FCT-M-N1	8"	31° Angle 1 ³ / ₁₆ " Deep	16 oz.	\$ 50.00

MIDWEST *Malco* **Jones Stephens Corp.** MISC. TOOLS



MIDWEST **DUCT STRETCHER**

SSC No.	Manuf No.	Wgt	Price Each
54E 1380	FTC-M-D1	12 oz	\$ 31.00

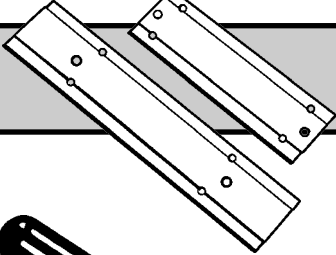

FOLDING TOOLS
FOLDS 24 TO 30 GAUGE MILD STEEL. 3/8" OR 1/2" DEEP FOLDS. HANGUP HOLE.

SSC No.	Manuf No.	Length	Folding Depth	Wgt.	Price Each
54E 1480	8	8"	3/8" & 1/2"	14 oz	\$ 14.22
54E 1510	FCT-M-F1	12"		20 oz	18.40

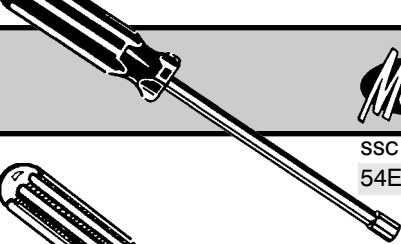

Malco **HEX HAND DRIVER**
1/4" HEX OPENING. 3/8" SHANK DIAMETER. 4 3/4" OVERALL LENGTH.

SSC No.	Manuf No.	Size	Price Each
54E 1140	HHD-1	1/2" Nose Diameter	\$ 15.67

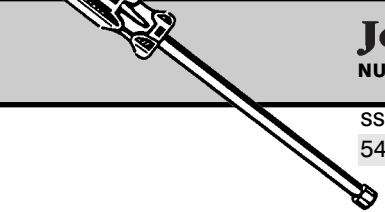

Jones Stephens Corp. NUT DRIVER
NUT DRIVER 5/16". 3/8" SHANK DIAMETER. 4 3/4" OVERALL LENGTH.

SSC No.	Manuf No.	Size	Price Each
54E 6024	S06-016	5/16"	\$ 15.33

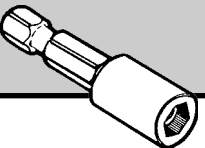

Jones Stephens Corp. MAGNETIC HEX CHUCK DRIVER

SSC No.	Manuf No.	Size	Wgt.	Price Each
54E 5900	S41-300	1/4" x 1"	.30 lbs	\$ 8.64

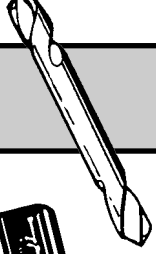

Malco **HIGH SPEED DOUBLE ENDER DRILL BITS**

SSC No.	Manuf No.	Size	Length	Wgt.	Price Each
54E 5820	DE-1/8	1/8"	2"	.20 lbs	\$ 3.12
54E 5830	DE-1/4	1/4"	2 1/2"	.20 lbs	5.88



SCRATCH AWLS

SSC No.	Manuf No.	Size	Price Each
Jones Stephens Corp. SCRATCH AWL			
54E 1160	S06-020	5 1/2" 7/32" x 3 1/2"	\$ 17.56
<i>Malco</i> SCRATCH AWL			
54E 1210	A-2	6 1/2" 1/4" x 4 1/2"	\$ 7.88



LENOX® SAWS & BLADES

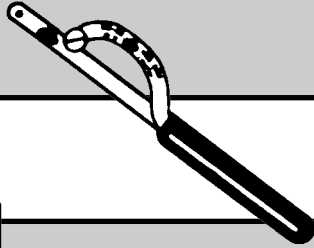

MINI SAW

FOR USE IN HARD TO REACH PLACES. NICKEL PLATED STEEL CONSTRUCTION. NON-SLIP VINYL CUSHION GRIP.

SSC No.	Manuf No.	Wgt	Price Each
54E 1010	MS-65	Uses All Standard Lengths of Blades	6 oz \$ 12.19

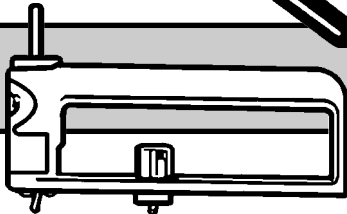

HOLE CUTTER

CUTS HOLES IN 20 GAUGE SHEET METAL. CAST ALUMINUM BODY. WEARING PARTS HEAT TREATED STEEL. USE WITH ANY STANDARD 1/4" ELECTRIC DRILL.

SSC No.	Manuf No.	Hole Diameter	Capacity	Wgt	Price Each
54E 5850	HC-1	2" to 12"	20 ga.	1.0 lbs	\$ 110.71
54E 5525	CB	Mill Type Replacement Cutting Bit		0.2 lbs	\$ 18.74

For More Information On These Products Or On Products Not Listed,
Call *Salina Supply Company* At (785) 823-2221

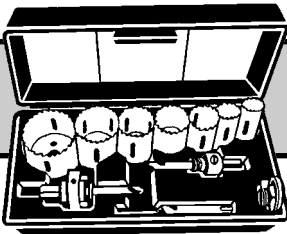

LENOX® HOLE SAW PLUMBER KIT IN PLASTIC CASE

SIX SIZES MOST COMMONLY USED FOR PIPE TAP & ENTRANCE. ONE EACH OF HOLE SAWS 3/4", 7/8", 1 1/8", 1 1/2", 1 3/4", 2 1/4" (19, 22, 29, 38, 44, 57MM). ONE EACH OF ARBORS 2L & 4L, SPARE PILOT DRILL & ARBOR ADAPTOR.

SSC No.	Manuf No.	Hole Saw Sizes	Price Each
54D 1340	30808-600P	3/4", 7/8", 1 1/8", 1 1/2", 1 3/4", 2 1/4"	\$ 185.38

LENOX® HOLE SAW CUTTER ONLY

FOR USE ON: •STAINLESS STEEL •WOOD •MILD STEEL •BRASS •ALUMINUM •TOOL STEEL •CAST IRON

SSC No.	Manuf No.	Diameter	Pipe Tap	Pipe Entrance	Use Arbor No.	Price Each
54D 1060	30012-12L	3/4" (19)	1/2" (13)	3/8" (10)	1L, 4L, 5L	\$ 14.81
54D 1080	30014-14L	7/8" (22)	3/4" (19)	1/2" (13)	1L, 4L, 5L	14.81
54D 1100	30016-16L	1" (25)			1L, 4L, 5L	16.05
54D 1120	30018-18L	1 1/8" (29)	1" (25)	3/4" (19)	1L, 4L, 5L	16.05
54D 1140	30022-22L	1 3/8" (35)		1" (25)	2L or 6L	\$ 16.91
54D 1160	30024-24L	1 1/2" (38)	1 1/4" (32)		2L or 6L	16.91
54D 1180	30028-28L	1 3/4" (44)	1 1/2" (38)	1 1/4" (32)	2L or 6L	21.24
54D 1200	30032-32L	2" (51)		1 1/2" (38)	2L or 6L	21.24
54D 1220	30036-36L	2 1/4" (57)	2" (51)		2L or 6L	25.64
54D 1240	30040-40L	2 1/2" (64)		2" (51)	2L or 6L	27.63
54D 1260	30048-48L	3" (76)		2 1/2" (64)	2L or 6L	28.62
54D 1280	30058-58L	3 5/8" (92)		3" (76)	2L or 6L	34.00
54D 1300	30066-66L	4 1/8" (105)		3 1/2" (90)	2L or 6L	46.96
54D 1320	30076-76L	4 3/4" (121)	4 1/2" (115)	4" (102)	2L or 6L	94.41

Inches (mm)

Electron
Beam Welded M2
High Speed
Steel Cutting Edge
Rc63-65
Spring Steel Back
1 1/2" (38mm)
Cutting Edge

LENOX® SAW BLADES

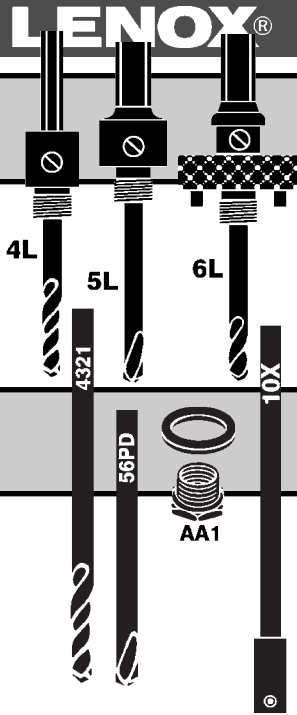

LENOX® ARBORS FOR HOLE SAW ONLY

SSC No.	Manuf No.	Shank Type	Chuck Size	For Hole Saw No.	Price Each
54D 1000	30004-4L	Round	1/4" (6)	9L-19L	\$ 15.53
54D 1020	30005-5L	Hex	3/8" (10)	9L-19L	22.69
54D 1040	30006-6L	Hex	3/8" (10)	20L-96L	34.58

Inches (mm)

LENOX® MISC PARTS FOR HOLE SAW

SSC No.	Manuf No.	Product	Chuck Size	Use Arbor No.	Price Each
54D 1380	30850-4321	Pilot Drill	1/4" (6)	1L, 2L, 4L	\$ 7.53
54D 1400	30851-56PD	Pilot Drill	1/4" (6)	5L, 6L	6.69
54D 1420	30857-AA1	Arbor Adaptor		1L, 4L, 5L	5.75
54D 1360	30843-10X	10" (250mm) Extension	3/8" (10)	5L, 6L	29.07

Inches (mm)

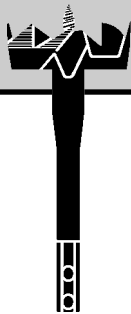

LENOX® LEADER BITS

SSC No.	Manuf No.	Diameter		Price Each
54D 1500	33100-LL100	1"	Leader Wood Bit	\$ 44.19
54D 1520	33137-LL137	1 3/8"	Leader Wood Bit	44.19
54D 1540	33200-LL200	2"	Leader Wood Bit	53.75
54D 1560	33212-LL212	2 1/8"	Leader Wood Bit	54.46
54D 1580	33256-LL256	2 9/16"	Leader Wood Bit	64.67
54D 1600	33362-LL362	3 5/8"	Leader Wood Bit	199.10
54D 1620	33462-LL462	4 5/8"	Leader Wood Bit	235.25

ACCESSORIES FOR LEADER BITS

54D 1640	33900-12LS	Leader Lead Screws	5 Per Pack	\$ 3.91
54D 1660	33901-34LS	#34 Leader Lead Screw	1 Per Pack	5.92
54D 1680	32985-HWS	Hex Wrench Set 1/8" for Leader & 5/32" for Extension		2.91
54D 1700	32510-STF	Slim Tapper File With Handle		14.36

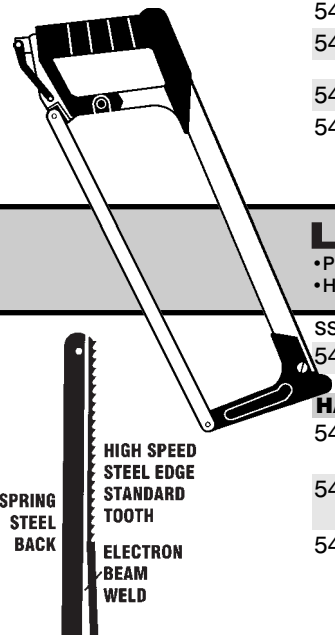

LENOX® HIGH TENSION HACK SAW FRAME

•PERMANENT HARDENED/SERRATED BLADE HOLDING PINS •45° BLADE HOLDER PINS FOR FLUSH CUTTING
 •HEAVY-DUTY HANDLE •RECTANGULAR STEEL CROSSBAR •BLADE STORAGE •STEEL TENSIONING NUT

SSC No.	Manuf No.	Blade Tensions to 30,000 PSI	Wgt	Price Each
54E 1610	20918-4012		1.4 lbs	\$ 51.88

HACK SAW BLADES

SSC No.	Manuf No.	Lgth x Wth x Thick - Inches (mm)	Teeth Per Inch/25 mm	Price Each
54D 0010	20116-218HE	12" x 1/2" x .025 (300 x 13 x .64)	18	\$ 3.00
54D 0030	20145-224HE	12" x 1/2" x .025 (300 x 13 x .64)	24	3.03
54D 0050	20118-232HE	12" x 1/2" x .025 (300 x 13 x .64)	32	3.00

continued on next page

LENOX® HOLE SAW KIT & PARTS

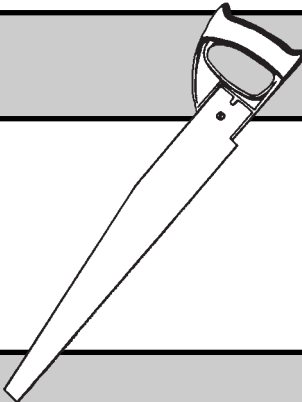

LENOX® PVC/ABS PLASTIC PIPE HAND SAW

SSC No.	Manuf No.		Price Each
54P 0050	20985-HSF-120	12" Blade & Handle	\$ 24.21
54P 0100	20980-HSF-180	18" Blade & Handle	27.28
54P 0075	20982-HSB-12	12" Replacement Blade	\$ 15.28
54P 0110	20981-HSB-180	18" Replacement Blade	14.65

LENOX® SAW BLADES

SSC No.	Manuf No.	Blade Size	Teeth Per Inch	Price Per 5 Blade Pack
CONTOURS IN NAIL FREE WOOD				
54D 0170	20556-676RC	6" x 7/16" X .050	6	\$ 30.74
NAIL FREE WOOD				
54D 0330	20575-634R	6" x 3/4" x .035	4	\$ 26.59
ROUGH WORK IN NAIL EMBEDDED WOOD				
54D 0310	20572-656R	6" x 3/4" x .050	6	\$ 28.91
54D 0410	20582-956R	9" x 3/4" x .050	6	38.34
54D 0450	20585-156R	12" x 3/4" x .050	6	46.84
ROUGH WORK IN NAIL EMBEDDED WOOD & ALL COMPOSITION MATERIAL				
54D 0190	20560-606R	6" x 3/4" x .035	6	\$ 24.30
NAIL EMBEDDED WOOD, PLAS., COMPOS., CAST ALUM. & LIGHT NON-FERROUS METAL				
54D 0390	20580-810R	8" x 3/4" x .035	10/14	\$ 30.74
54D 0210	20562-610R	6" x 3/4" x .035	10	24.30
ALL WOODS, PLASTIC & CAST ALUMINUM				
54D 0430	20583-110R	12" x 3/4" x .050	10/14	\$ 46.84
PLASTER & PLASTER BOARD				
54D 0290	20570-636RP	6" x 3/4" x .050	6	\$ 28.91
HARD TO CUT ABRASIVE MATERIALS, FIBERGLASS, CERAMIC TILE & CAST IRON PIPE				
54D 0350	20576-800RG	8" x 3/4" x .042	Medium Carbide Grit	\$ 26.59
METAL - IRREGULAR CONTOURS				
54D 0070	20520-314RC	3" x 1/4" x .032	14	\$ 22.88
METAL - CONTOURS UNDER 1/8"				
54D 0090	20521-318RC	3" x 1/4" x .032	18	\$ 22.88
HEAVY GAUGE METAL, RUBBER & FIBER				
54D 0110	20550-414R	4" x 3/4" x .035	14	\$ 18.84
54D 0230	20564-614R	6" x 3/4" x .035	14	24.30
HEAVY GAUGE METAL, CONDUIT & TUBING				
54D 0130	20552-418R	4" x 3/4" x .035	18	\$ 18.84
54D 0250	20566-618R	6" x 3/4" x .035	18	24.30
54D 0370	20578-818R	8" x 3/4" x .035	18	30.74
METAL & GALVANIZED PIPE 18 GAUGE & UNDER				
54D 0150	20554-424R	4" x 3/4" x .035	24	\$ 18.84
54D 0270	20568-624R	6" x 3/4" x .035	24	24.30

LENOX® Jones Stephens Corp.

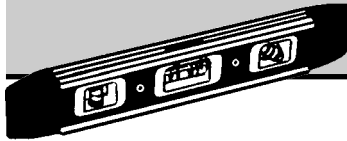

LENOX® TORPEDO LEVEL

SSC No.	Manuf No.	Size	Price Each
54E 0175	21190-LV9T	9"	\$ 42.35



Jones Stephens Corp. LOCKING MEASURING TAPE

•UNBREAKABLE CHROME PLATED CASE •POWER RETURN •DOUBLE RIVETED TANG •POSITIVE LOCK

SSC No.	Manuf No.	Size	Wgt.	Price Each
54E 6020	J40-045	3/4" x 16'	Yellow Tape .8 lbs	\$ 29.74

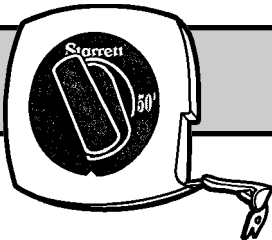

Jones Stephens Corp. 50' LONG TAPE RULE

•HOOK BLADE •POP-OPEN HANDLE

SSC No.	Manuf No.	Size	Price Each
54E 6030	J40-088	3/8" x 50'	\$ 45.51



Jones Stephens Corp. CHROME PRECISION TAPE

•1" LOCKING BLADE •TOUGH TIP

SSC No.	Manuf No.	Size	Price Each
54E 1000	J40-085	1" x 25' Chrome Tape	\$ 28.33

For More Information On These Products Or On Products Not Listed,
Call *Salina Supply Company* At (785) 823-2221

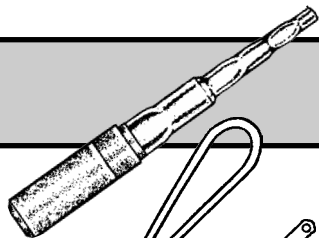

COMBINATION SWEDGING TOOL

ELIMINATES COUPLING BY SWEDGING OUT END OF TUBE. INDUSTRIAL QUALITY.

SSC No.	Manuf No.	Tube Sizes ID	Wgt.	Price Each
54E 4760	6502	3/8" 1/2" 3/4"	.5 lbs	\$ 16.30

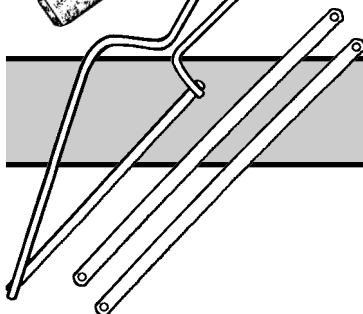

Jones Stephens Corp. CLOSE QUARTERS HACKSAW

NICKEL PLATED STEEL FRAME • CUTS WOOD, PLASTIC, BRASS, ALUMINUM & STEEL

SSC No.	Manuf No.	Length	Price Each
54H 3510	S50-060	6"	\$ 4.61
54H 3560	S50-061	6" Blades For S50-060	\$ 1.12

Flexible Plumbertool, Inc.

RIDGID

**General
PIPE CLEANERS**

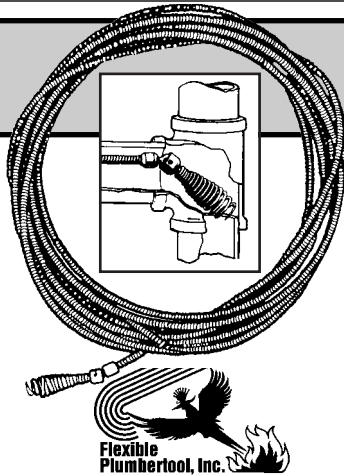

FLEXIBLE DROP-HEAD SNAKES

THESE 1/4" THROUGH 7/16" SNAKES ARE MADE OF SWEDISH MUSIC WIRE DRAWN ESPECIALLY TO HAVE MAXIMUM HARDNESS, YET FLEXIBILITY & RESISTANCE TO CRYSTALLIZATION. 1/2" SNAKES ARE MADE OF REINFORCED HARD DRAWN OIL TEMPERED WIRE FOR ADDED STRENGTH.

SSC No.	Manuf No.	Size	Wgt	Price Each
54M 1610	PS-1425	1/4" x 25'	3.5 lbs	\$ 48.08
54M 1710	PS-1625	5/16" x 25'		64.60
54M 1760	PS-1635	5/16" x 35'	7.0 lbs	64.00
54M 1810	PS-3825	3/8" x 25'		74.67
54M 1910	PS-3850	3/8" x 50'	14.0 lbs	102.00
54M 2010	PS-71675	7/16" x 75'		150.04
54M 2140	PSR-1425	1/4" x 25' Reinforced		\$ 49.33
54M 2135	PSR-3825	3/8" x 25' Reinforced	9.0 lbs	83.01
54M 2170	PSR-3835	3/8" x 35' Reinforced		103.68
54M 2130	PSR-1250	1/2" x 50' Reinforced		165.65

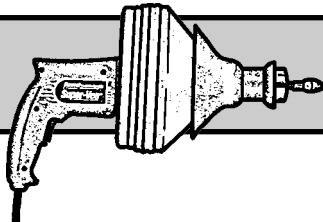

**General
PIPE CLEANERS**

SUPER-VEE SMALL DRAIN CLEANER

WITH CABLE & CASE • FOR DRAINS UP TO 3" • SLIDE-ACTION CHUCK IN GRIP SHIELD
DOUBLE INSULATED MOTOR • REVERSE & VARIABLE SPEED SWITCH.

SSC No.	Manuf No.	Wgt	Price Each
54M 2110	SV-B-WC	10 Lbs	\$ 644.25

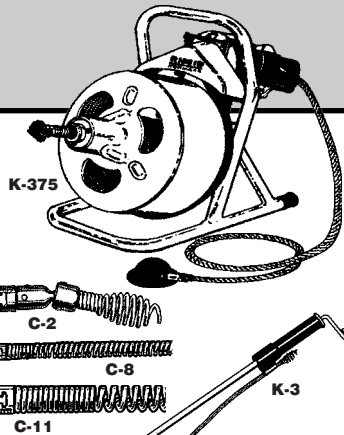

RIDGID DRAIN CLEANER

1/3 HP MOTOR SPINS CABLE AT 190 RPM. DRUM CAPACITY IS 100' OF 3/8" (1 1/2" TO 3" LINES)
OR 75' OF 1/2" (2" TO 4" LINES) CONTINUOUS LENGTH CABLE.

SSC No.	Manuf No.	Size	Wgt	Price Each
54A 2500	87292 K-380	1/2" x 50'	1 1/2" to 4" indoor lines 69 lbs	\$ 806.47
54A 4150	62235 C-2	5/16" x 25'	Drop Head Cable	\$ 76.81
54A 4200	62270 C-8	5/8" x 7 1/2'	Cable For Small Lines	36.26
54A 4220	62280 C-11	1 1/4" x 15'	Cable for 3" to 8" Lines	121.48
54M 2200	59787 K-3	3'	Regular Hand Closet Auger	\$ 44.60
54M 2210	59792 K-3DH	3'	Drop Head Hand Closet Auger	53.67

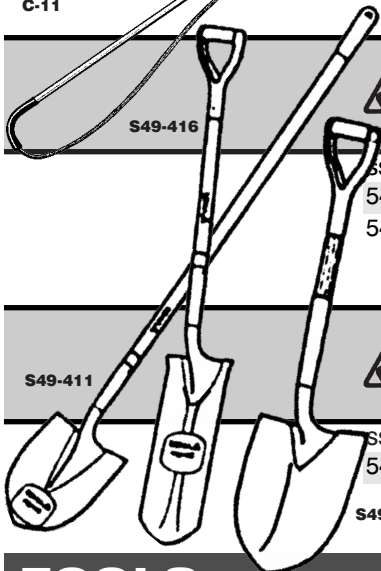

AMES STINGER SERIES SHOVELS

• FIBERGLASS HANDLE • LARGE STEEL COLLAR • FORWARD-TURNED STEP

SSC No.	Manuf No.	Price Each
54P 2000	S49-411	Long Handle Round Point Shovel \$ 53.80
54P 2100	S49-416	D-Handle 16" Drain Spade 63.16

AMES KODIAK CUB COMPACT UTILITY SHOVEL

• EASIER USE IN TIGHT SPACES • 16 GAUGE TEMPERED STEEL BLADE
• FORWARD-TURNED STEP • 27" OVERALL LENGTH

SSC No.	Manuf No.	Price Each
54P 2200	S49-429	Compact Utility Shovel \$ 28.32

TOOLS

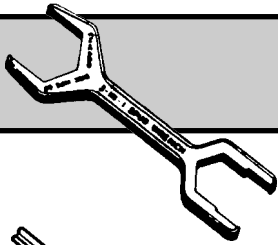

CHICAGO 3 IN 1 CLOSET SPUD WRENCH

SSC No.	Manuf No.	Capacity	Price Each
54P 0330	3001/J40-305	1 1/4" 1 1/2" 2"	\$ 10.58

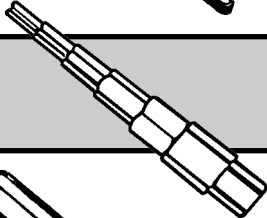

CHICAGO RADIATOR NIPPLE & VALVE WRENCH

SSC No.	Manuf No.	Capacity	Price Each
54P 0370	3007	1/2" 3/4" 1 1/4" 1 1/2" 2"	\$ 16.52

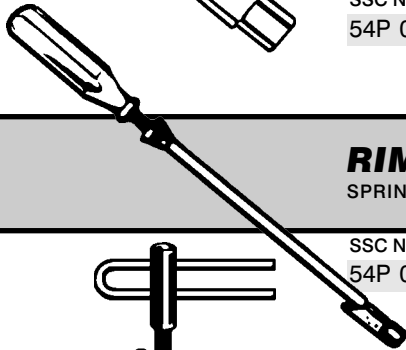

RIMSTER SINK RIM SCREWDRIVER

SPRING LOADED FOR STANDARD 12 TO 24 HEX HEAD BOLTS.

SSC No.	Manuf No.	Length	Price Each
54P 0460	3015	14"	\$ 20.52

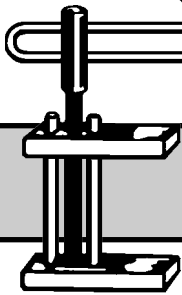

SPEEDY SPUD WRENCH

HARDENED STEEL & BRIGHT PLATED.

SSC No.	Manuf No.	Capacity	Wgt.	Price Each
54P 0560	3030	1" to 4"	1.5 lbs	\$ 33.13

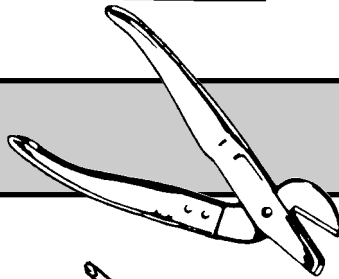

PIPE CRIMPERS

MAKES FAST, UNIFORM CRIMPS UP TO 1 1/2".

SSC No.	Manuf No.	Capacity	Price Each
54P 0610	SC1	Up To 1 1/2" In Up To 20 Ga.	\$ 20.10

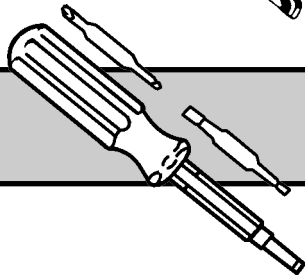

4 IN 1 SCREWDRIVER

SSC No.	Manuf No.	Price Each
54P 0715	S41-001	For Slotted & Phillips Head \$ 15.41

For More Information On These Products Or On Products Not Listed,
Call *Salina Supply Company* At (785) 823-2221

TOOLS

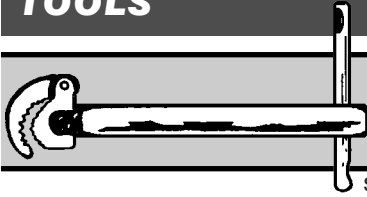

BASIN WRENCH

1 1/4" JAW CAPACITY

SSC No.	Manuf No.	Size	Wgt.	Price Each
54P 1060	B11-011	11"	1.50 lbs	\$ 12.38
54P 1110	B11-010	10" to 17" Telescoping	1.75 lbs	24.86

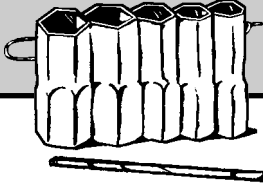

TUB & SHOWER VALVE WRENCH SET

PLATED STEEL. COMPLETE WITH HANDLE.

SSC No.	Manuf No.	Size	Wgt.	Price Each
54P 1150	J40-002	5 Sockets On Wire Clip	2.25 Lb	\$ 17.48



UNIVERSAL FIXTURE HANGER

SSC No.	Manuf No.	Size	Price Each
54P 1180	L56-022	For Vitreous China Fixtures	\$.82

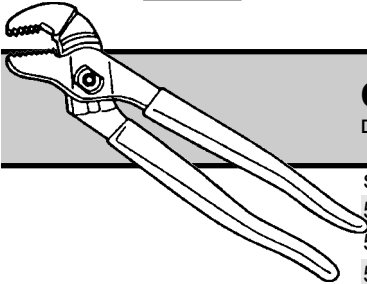

GROOVE JOINT PLIERS

DROP FORGED. CHROME PLATED. CUSHION HANDLES.

SSC No.	Manuf No.	Length	Max Jaw Opening	Price Each
54P 1315	J40-401	7"	7/8"	\$ 34.68
54P 1290	J40-403	10"	1 1/2"	44.02
54P 1320	J40-404	12"	2 1/2"	47.62

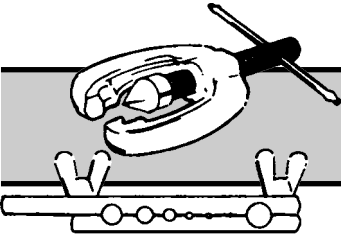

BAR FLARING TOOL

MAKES SMOOTH FLARE.

SSC No.	Manuf No.	Flares O.D. Tubing	Wgt.	Price Each
54P 4310	J40-080	3/16" 1/4" 5/16" 3/8" 1/2" 5/8"	1.25 Lb	\$ 19.79

For More Information On These Products Or On Products Not Listed,
Call *Salina Supply Company* At (785) 823-2221

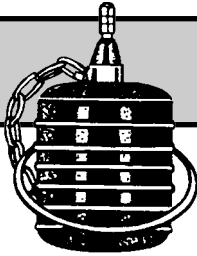
TOOLS**CHERNE PNEUMATIC TEST-BALL PLUG**

SSC No.	Manuf No.	Nominal Size	Wgt.	Price Each
54P 5810	270-016	1 ¹ / ₄ " 1 ¹ / ₂ "	.22 lbs	\$ 32.94
54P 5860	270-024	2"	.22 lbs	35.11
54P 5910	270-032	3"	.41 lbs	37.98
54P 5920	270-040	4"	.56 lbs	44.07
54P 5940	270-067	6"	1.91 lbs	110.02

**CHERNE HAND TEST PUMP WITH GAUGE**

SSC No.	Manuf No.	Wgt.	Price Each
54P 5990	273-945	4.75 lbs	\$ 40.68

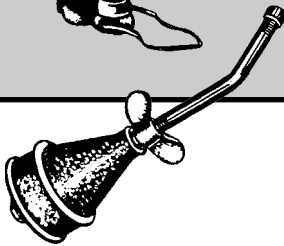
**WING NUT TYPE TEST PLUG**

SSC No.	Manuf No.	Size	Wgt.	Price Each
54P 6110	T39-002	2"	1.5 lbs	\$ 21.92
54P 6120	T39-003	3"	2.5 lbs	28.20
54P 6130	T39-004	4"	3.25 lbs	35.41
54P 6150	T39-006	6"	6.25 lbs	56.10

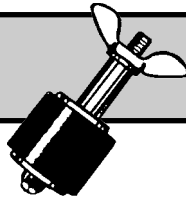
**KWIK-N-SURE WING NUT TYPE TEST PLUG**

SSC No.	Manuf No.	Size	Wgt.	Price Each
54P 6400	269-883	1 ¹ / ₄ "	0.40 lbs	\$ 5.06

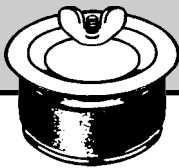
**ECON-O-GRIP TEST PLUG**

SSC No.	Manuf No.	Size	Wgt.	Price Each
54P 6410	271-519	1 ¹ / ₂ "	0.40 lbs	\$ 2.96
54P 6420	271-527	2"	0.60 lbs	3.35
54P 6430	271-535	3"	0.80 lbs	4.67
54P 6440	271-543	4"	0.11 lbs	5.87

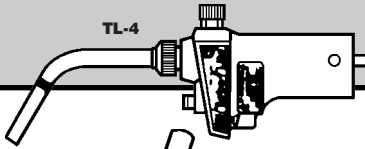

TURBOLITE SELF-LIGHTING TORCH

USE WITH MAPP OR PROPANE GAS. FLAME TUBE SWIVELS 180°.

SSC No.	Manuf No.		Price Each
42D 2378	TX504/TL-44	Equivalent to T-4 Tip	\$ 120.56
42D 2369	ST-33	Turbolite Tip Only	73.21

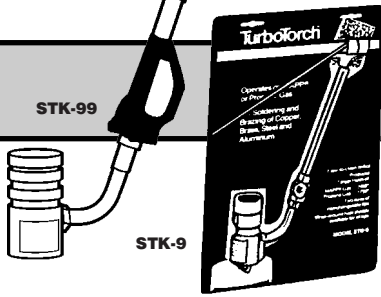

HAND TORCH KITS

• FOR STANDARD PROPANE OR MAPP GAS TANKS • FOR SOLDERING & BRAZING • INSTRUCTION MANUAL
 • STK-R PRESSURE REGULATOR CGA-600 • STEM SWIVELS 360° • EASY TO CHANGE ORIFICE

SSC No.	Manuf No.		Price Each
42D 2383	STK-99	ST-33 Self Lighting Push-Button Tip	\$ 104.75
42D 2381	STK-9	ST-3 Tip	87.79

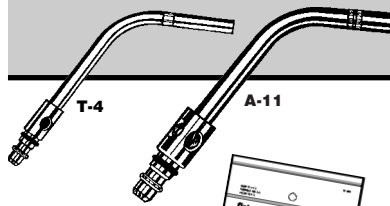

PROPANE OR SWIRL AIR ACETYLENE TIPS

SSC No.	Manuf No.	Soft Solders To	Silver Solders To	Flame	Price Each
42D 2408	T-4 Propane Only	3/8" to 2 1/2"	1/4" to 1 3/8"	1/4"	\$ 90.84
42D 2405	A-11 Acetylene	1 1/2" to 3"	7/8" to 1 5/8"	7/16"	79.67



Oatey FLAME PROTECTOR

9" x 12" WOVEN CERAMIC (NON-ASBESTOS) HEAT SHEILD. PROTECTS WORK AREAS FROM TORCHES UP TO 2000° F.

SSC No.	Manuf No.	Size	Price Each
42D 1700	31400	9" x 12"	\$ 18.72



SINGLE FLINT STRIKER

CUP TYPE • ROUND FILE

SSC No.	Manuf. No.	Price Each
42D 1780	J40-048/L-1	\$ 5.20

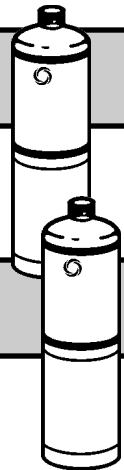

MAPP GAS TANK

SSC No.	Manuf. No.	Price Each
42D 2385	MT-1/J40-600	16 oz. \$ 17.73



SILVERFLOW BRAZING ROD

SSC No.	Manuf. No.	Price Each
26N3330	SF-1	\$ 21.32

PROPANE GAS TANK

SSC No.	Manuf. No.	Price Each
42D 2387	PT-1/J40-601	14.1 oz. \$ 10.12



COOL ZONE

PREVENTS HEAT DAMAGE WHILE BRAZING, SOLDERING & WELDING.

SSC No.	Manuf No.		Price Each
42E 0005	CZ-1Q	Spray Bottle	Quart \$ 12.21