

ABS PLASTIC

Note: All Prices On This Page Have Changed

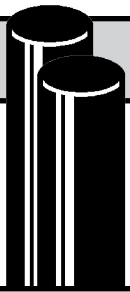

ABS PLASTIC PIPE

SSC No.	Size	Length	Price Each	Price Per 100'
26G 0020	1 1/2"	20'	\$ 25.16	\$ 125.80
26G 0030	2"	20'	34.31	171.55
26G 0050	3"	20'	70.30	351.50
26G 0070	4"	20'	104.19	520.95



ABS COUPLING

SSC No.	Manuf No.	Size	Ctn	Price Each
26G 0250	100	1 1/4"	75	\$ 1.08
26G 0260	100	1 1/2"	60	.71
26G 0270	100	2"	45	.96
26G 0290	100	3"	60	2.77
26G 0320	100	4"	45	5.01
26G 0323	100	6"	10	20.87

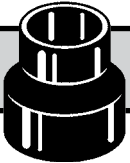

ABS REDUCER COUPLING

SSC No.	Manuf No.	Size	Ctn	Price Each
26G 0330	102	1 1/2" x 2"	25	\$ 2.06



ABS REPAIR COUPLING

SSC No.	Manuf No.	Size	Ctn	Price Each
26G 0350	130	1 1/2"	60	\$ 4.95
26G 0360	130	2"	45	2.48
26G 0370	130	3"	60	6.40



ABS BUSHING

SSC No.	Manuf No.	Size	Ctn	Price Each
26G 0410	107	1 1/2" x 1 1/4"	120	\$ 3.62
26G 0420	107	2" x 1 1/2"	65	1.17
26G 0430	107	2" x 1 1/4"		1.40
26G 0440	107	3" x 2"	40	3.21
26G 0450	107	3" x 1 1/2"	30	4.97
26G 0470	107	4" x 3"	30	5.08
26G 0480	107	4" x 2"	20	9.52
26G 0490	107	6" x 4"	25	25.43

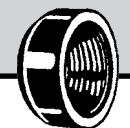

ABS CLEANOUT BUSHING

SSC No.	Manuf No.	Size	Ctn	Price Each
26G 0570	2755/2915	3" x 2"	40	\$ 32.10
26G 0580	2914	3" x 1 1/2"		29.06

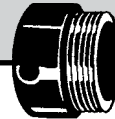

ABS MALE ADAPTER

SSC No.	Manuf No.	Size	Ctn	Price Each
26G 0610	109	1 1/4"	70	\$ 1.35
26G 0620	109	1 1/2"	50	1.12
26G 0625	109	1 1/2" x 1 1/4"	90	1.38
26G 0630	109	2"	40	1.63
26G 0640	109	3"	30	4.79
26G 0650	109	4"	10	10.58

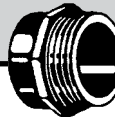

ABS MALE FITTING ADAPTER

SSC No.	Manuf No.	Size	Ctn	Price Each
26G 0680	111	1 1/2"		\$ 3.03
26G 0690	111	2"		6.11



ABS TRAP ADAPTER

SSC No.	Manuf No.	Size	Ctn	Price Each
26G 0820	2850A	1 1/4"	60	\$ 1.62
26G 0840	104-P	1 1/2"	75	1.81
26G 0870	104-P	1 1/2" x 1 1/4"	50	1.99

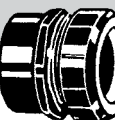

ABS MALE FITTING TRAP ADAPTER

SSC No.	Manuf No.	Size	Ctn	Price Each
26G 0910	2800A	1 1/4"	90	\$ 1.73
26G 0930	103-P	1 1/2"	50	1.98
26G 0940	103-P	1 1/2" x 1 1/4"	75	2.43

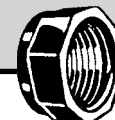

ABS FEMALE ADAPTER

SSC No.	Manuf No.	Size	Ctn	Price Each
26G 1020	101	1 1/2"	50	\$ 1.31
26G 1050	101	2"	50	2.08
26G 1070	101	3"	20	5.55
26G 1080	101	4"	10	6.59
26G 1081	101	6"	10	24.36

continued on next page

ABS PLASTIC

Note: All Prices On This Page Have Changed

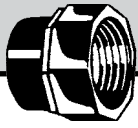

ABS FEMALE FITTING ADAPTER

SSC No.	Manuf No.	Size	Ctn	Price Each
26G 1085	105	1 1/4"	100	\$ 2.83
26G 1090	105	1 1/2"	65	1.44
26G 1110	105	2"	35	2.21
26G 1120	105	3"	25	5.66
26G 1140	105	4"	10	10.41



ABS 60° BEND

SSC No.	Manuf No.	Size	Ctn	Price Each
26G 1580	319	1 1/2"	40	\$ 2.39
26G 1590	319	2"	20	3.41
26G 1610	319	3"	30	11.91
26G 1620	319	4"	10	17.02



ABS THREADED PLUG

SSC No.	Manuf No.	Size	Ctn	Price Each
26G 1160	3050	1 1/4"	200	\$ 2.78
26G 1170	106	1 1/2"	120	.91
26G 1180	106	2"	80	1.20
26G 1190	106	3"	30	1.93
26G 1200	106	3 1/2"	25	7.22
26G 1210	106	4"	30	3.37
26G 1212	106	6"	10	11.41



ABS 90° ELL VENTS

SSC No.	Manuf No.	Size	Ctn	Price Each
26G 1720	331	1 1/2"	40	\$ 2.30
26G 1730	331	2"	30	3.95
26G 1740	331	3"	20	9.41



ABS 90° STREET ELL VENT

SSC No.	Manuf No.	Size	Ctn	Price Each
26G 1790	333	1 1/2"		\$ 2.33
26G 1810	333	2"		3.75



ABS 22 1/2° BENDS

SSC No.	Manuf No.	Size	Ctn	Price Each
26G 1280	324	1 1/2"	30	\$ 1.83
26G 1290	324	2"	40	2.26
26G 1310	324	3"	30	5.87
26G 1340	324	4"	15	8.92



ABS 90° ELLS

SSC No.	Manuf No.	Size	Ctn	Price Each
26G 1950	300	1 1/4"	50	\$ 1.92
26G 1960	300	1 1/2"	75	1.43
26G 1970	300	2"	25	2.28
26G 1990	300	3"	30	5.75
26G 2010	300	4"	10	11.54
26G 2015	300	6"	5	50.33



ABS 22 1/2° STREET BEND

SSC No.	Manuf No.	Size	Ctn	Price Each
26G 1370	326	1 1/2"	50	\$ 5.69
26G 1380	326	2"	45	5.15
26G 1390	326	3"	30	8.74
26G 1410	326	4"	15	13.87



ABS 90° STREET ELL

SSC No.	Manuf No.	Size	Ctn	Price Each
26G 2030	302	1 1/2"	45	\$ 1.77
26G 2050	302	2"	40	2.95
26G 2080	302	3"	25	6.23
26G 2110	302	4"	10	14.02



ABS 45° BENDS

SSC No.	Manuf No.	Size	Ctn	Price Each
26G 1420	321	1 1/4"	50	\$ 1.94
26G 1450	321	1 1/2"	40	1.35
26G 1460	321	2"	25	2.10
26G 1470	321	3"	20	4.86
26G 1480	321	4"	10	9.56
26G 1485	321	6"	5	39.34



ABS 90° ELL WITH LOW HEEL INLET

SSC No.	Manuf No.	Size	Ctn	Price Each
26G 2160	307	3" x 3" x 2"	25	\$ 8.39



ABS 45° STREET BEND

SSC No.	Manuf No.	Size	Ctn	Price Each
26G 1490	323	1 1/4"	40	\$ 1.81
26G 1510	323	1 1/2"	45	1.69
26G 1520	323	2"	30	2.24
26G 1530	323	3"	30	5.11
26G 1540	323	4"	10	8.88
26G 1550	323	6"	6	51.65



ABS 90° LONGSWEEP ELL

SSC No.	Manuf No.	Size	Ctn	Price Each
26G 2180	304	1 1/2"	55	\$ 2.42
26G 2190	304	2"	30	3.19
26G 2210	304	3"	15	7.83
26G 2250	304	4"	4	13.50

ABS PLASTIC

Note: All Prices On This Page Have Changed



ABS 3-WAY ELL

SSC No.	Manuf No.	Size	Ctn	Price Each
26G 3640	327	1 1/2"	70	\$ 5.34
26G 3645	327	2"	35	8.59
26G 3650	327	3"	10	26.22

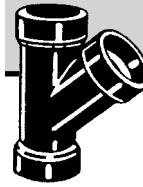

ABS 45° WYE

SSC No.	Manuf No.	Size	Ctn	Price Each
26G 2430	600	1 1/4"	35	\$ 2.94
26G 2450	600	1 1/2"	55	3.36
26G 2460	600	2"	25	4.37
26G 2480	601	2" x 1 1/2"	35	6.38
26G 2510	600	3"	10	10.32
26G 2530	601	3" x 3" x 2"	15	7.43
26G 2540	601	3" x 1 1/2"	15	8.26
26G 2560	600	4"	10	20.99
26G 2570	601	4" x 4" x 3"	10	16.55
26G 2580	601	4" x 2"	10	12.24
26G 2565	600	6"	2	62.50
26G 2590	601	6" x 6" x 4"	5	51.64



ABS SANITARY TEE

SSC No.	Manuf No.	Size	Ctn	Price Each
26G 2980	400	1 1/4"	25	\$ 2.56
26G 3010	400	1 1/2"	50	2.19
26G 3040	2132	1 1/2" x 1 1/4"	35	3.96
26G 3050	400	2"	50	3.38
26G 3080	401	2" x 2" x 1 1/2"	30	2.95
26G 3110	401	2" x 1 1/2" x 1 1/2"	35	3.01
26G 3113	401	2" x 1 1/2" x 2"	25	3.42
26G 3120	400	3"	15	9.29
26G 3140	401	3" x 3" x 2"	20	6.76
26G 3160	401	3" x 3" x 1 1/2"	20	5.61
26G 3210	400	4"	12	16.41
26G 3220	401	4" x 4" x 2"	10	16.11
26G 3230	401	4" x 3"	10	10.55



ABS 45° DOUBLE WYE

SSC No.	Manuf No.	Size	Ctn	Price Each
26G 2780	611	1 1/2"	40	\$ 10.08
26G 2790	611	2"	20	12.03
26G 2810	611	3"	10	27.40
26G 2840	612	3" x 3" x 2" x 2"	20	20.16
26G 2890	611	4"	5	53.64
26G 2900	612	4" x 4" x 3" x 3"	6	42.47
26G 2920	612	4" x 4" x 2" x 2"	5	24.32



DOUBLE SANITARY TEE

SSC No.	Manuf No.	Size	Ctn	Price Each
26G 3290	428	1 1/2"	50	\$ 4.95
26G 3320	428	2"	25	7.22
26G 3350	429	2" x 1 1/2"	20	5.80
26G 3370	428	3"	15	20.53
26G 3390	429	3" x 2"	20	12.21
26G 3450	428	4"	8	36.31
26G 3455	429	4" x 2"	15	34.11

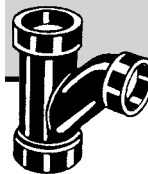

ABS WYE & 1/8 BEND COMBINATION

SSC No.	Manuf No.	Size	Ctn	Price Each
26G 3670	501	1 1/2"	50	\$ 5.23
26G 3690	501	2"	25	5.87
26G 3710	502	2" x 1 1/2"	20	8.61
26G 3730	501	3"	10	13.39
26G 3740	502	3" x 2"	12	8.98
26G 3750	502	3" x 1 1/2"	15	13.52
26G 3770	501	4"	5	26.59
26G 3780	502	4" x 3"	8	20.90
26G 3790	502	4" x 2"	15	16.29



DOUBLE SANITARY TEES WITH SIDE INLETS

SSC No.	Manuf No.	Size	Ctn	Price Each
ABS DOUBLE SANITARY TEE WITH SIDE INLET				
			10	
26G 3480	438	3" x 3" x 3" x 3" x 2"		\$ 21.28
ABS DOUBLE SANITARY TEE WITH LEFT SIDE INLET				
			10	
26G 3530	416	3" x 3" x 3" x 2"		\$ 21.30
ABS DOUBLE SANITARY TEE WITH RIGHT SIDE INLET				
			10	
26G 3570	417	3" x 3" x 3" x 2"		\$ 12.78
ABS DOUBLE SANITARY TEE WITH RIGHT & LEFT SIDE INLET				
			10	
26G 3510	418	3" x 3" x 3" x 2" x 2"		\$ 18.07



ABS CAP-ALL

SSC No.	Manuf No.	Size	Ctn	Price Each
26G 0800	101	1 1/2"		\$ 1.84
26G 0803	102	2"		3.13
26G 0806	103	3"		4.20
26G 0809	104	4"		4.75
26G 0810	CA	6"		4.78

continued on next page

ABS PLASTIC

*Price Change



ABS CLOSET BEND

SSC No.	Manuf No.	Size Hub x Spigot	Ctn	Price Each
26G 3950	330	4" x 3"	15	\$ 13.77 *



CAST IRON SPIGOT ADAPTER

SSC No.	Manuf No.	Size Hub x Hub	Ctn	Price Each
26G 4440	119	2"	20	\$ 3.59 *
26G 4460	122	4"	20	6.86



ABS CLOSET FLANGES

SSC No.	Manuf No.	Size	Ctn	Price Each
26G 4060	800	4" Hub	25	\$ 4.97 *
26G 4070	800	4" x 3" Hub	30	4.40 *

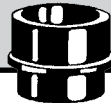

ABS ADAPTER COUPLING

SSC No.	Manuf No.	Size S&D x Hub	Ctn	Price Each
26G 4520	117	4" x 3"	45	\$ 7.09 *
26G 4530	117	4"		10.27 *



ABS CLOSET FLANGE WITH METAL RING

SSC No.	Manuf No.	Size	Ctn	Price Each
26G 3990	812	4" x 3" Spigot	35	\$ 13.55 *
26G 4020	43520	4" Hub	30	9.86 *
26G 4040	43512	4" or 3" Hub	30	6.80 *



ABS SLIP PLUG

SSC No.	Manuf No.	Size Spigot	Price Each
26G 4680	3055	1 1/2"	\$ 1.76

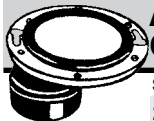

ABS ADJUSTABLE OFFSET CLOSET FLANGE

SSC No.	Manuf No.	Size	Ctn	Price Each
26G 4085	43500	4" or 3" Hub	25	\$ 11.48 *



INSET TEST CAP

SSC No.	Manuf No.	Size	Price Each
26G 4797	5817 P1	1 1/2"	\$.55
26G 4799	5817 P2	2"	.57
26G 4801	5817 P3	3"	.74
26G 4803	5817 P4	4"	.88



ABS P-TRAPS

SSC No.	Manuf No.	Size	Ctn	Price Each
ABS P-TRAP WITHOUT CLEANOUT				
26G 4240	706-X	1 1/2" Hub	40	\$ 4.72 *
26G 4260	706-X	2" Hub	20	6.21 *
26G 4285	706-X	4" Hub	6	48.79 *



ABS P-TRAP WITH CLEANOUT

26G 4190	707-X	1 1/2" Hub	35	\$ 7.53 *
----------	--------------	------------	----	-----------



ABS P-TRAP WITH UNION DOUBLE SEAL

26G 4115	708-P	1 1/2" Hub	40	\$ 6.35 *
----------	--------------	------------	----	-----------



ABS CLEAN-OUT TEE

SSC No.	Manuf No.	Hub x Hub x FPT	Ctn	Price Each
26G 4830	445	1 1/2"	15	\$ 5.25 *
26G 4840	445	2"	30	5.77 *
26G 4850	445	3"	20	10.82 *
26G 4870	445	4"	12	23.23 *



ABS RETURN BEND

SSC No.	Manuf No.	Size	Ctn	Price Each
26G 4310	700	1 1/2" Hub	75	\$ 3.51 *

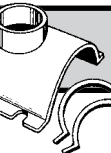

ABS SADDLE TEE KIT

SSC No.	Manuf No.	Size	Price Each
24A 9427	43788	3" x 2"	\$ 13.59



CAST IRON HUB ADAPTER

SSC No.	Manuf No.	Size Spigot x Hub	Ctn	Price Each
26G 4330	123-R	2" x 1 1/2"	15	\$ 4.17 *
26G 4350	123	2"	30	8.52 *
26G 4390	123	3"	30	8.44 *
26G 4370	3464/2960	4" x 3"	20	7.78
26G 4420	123	4"	10	13.71 *



ABS BLACK CEMENT

SSC No.	Manuf No.	Size	Price Each
26G 4930	30889	1/2 Pint	\$ 6.53
26G 4940	30892	1 Pint	10.37
26G 4950	30902	1 Quart	17.03

PVC/DWV PLASTIC

Note: All Prices On This Page Have Changed



PVC/DWV DUAL MARK PLASTIC PIPE

SSC No.	Size	Length	Price Each	Per 100'
26I 0001	1 1/4"	20'	\$ 18.22	\$ 91.10
26I 0002	1 1/2"	20'	17.06	85.30
26I 0003	2"	20'	22.89	114.45
26I 0004	3"	20'	48.76	243.80
26I 0005	4"	20'	66.94	334.70
26I 0006	6"	20'	153.70	768.50
26I 0007	8"	20'	186.66	933.30
26I 0008	10"	20'	307.58	1537.90

PVC/DWV FOAM CORE PLASTIC PIPE

SSC No.	Size	Length	Price Each	Per 100'
26I 1985	1 1/2"	20'	\$ 14.26	\$ 71.30
26I 1990	2"	20'	16.61	83.05
26I 2000	3"	20'	34.12	170.60
26I 2020	4"	20'	49.84	249.20

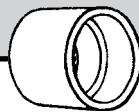

PVC/DWV COUPLING

SSC No.	Manuf No.	Size	Ctn	Price Each
26I 0010	100/4801	1 1/4"	75	\$ 2.49
26I 0020	100/4801	1 1/2"	60	.56
26I 0030	100/4801	2"	45	.73
26I 0040	100/4801	3"	60	2.52
26I 0050	100/4801	4"	45	4.46
26I 0060	100/4801	6"	10	14.53



PVC/DWV THREADED PLUG

SSC No.	Manuf No.	Size	Ctn	Price Each
26I 0380	3050/4818	1 1/4"	200	\$ 2.11
26I 0390	106/4818	1 1/2"	120	.99
26I 0400	106/4818	2"	80	1.10
26I 0410	106/4818	3"	30	1.97
26I 0420	106/4818	4"	30	2.91
26I 0430	106/4818	6"	10	9.68

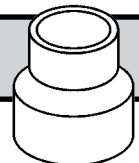

PVC/DWV REDUCER COUPLING

SSC No.	Manuf No.	Size	Ctn	Price Each
26I 0063	102	3" x 2"	20	\$ 3.80

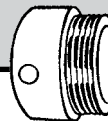

PVC/DWV MALE ADAPTER

SSC No.	Manuf No.	Size	Ctn	Price Each
26I 0150	109/4804	1 1/4"	70	\$ 2.50
26I 0160	109/4804	1 1/2" x 1 1/4"	25	1.43
26I 0170	109/4804	1 1/2"	50	1.09
26I 0180	109/4804	2"	40	1.41
26I 0190	109/4804	3"	30	4.05
26I 0200	109/4804	4"	10	8.98

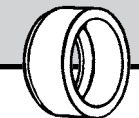

PVC/DWV BUSHING

SSC No.	Manuf No.	Size	Ctn	Price Each
26I 0070	107/48012F	1 1/2" x 1 1/4"	120	\$ 2.19
26I 0080	107/48012F	2" x 1 1/4"	70	2.24
26I 0090	107/48012F	2" x 1 1/2"	65	.96
26I 0100	107/48012F	3" x 1 1/2"	30	4.63
26I 0110	107/48012F	3" x 2"	40	2.42
26I 0120	107/48012F	4" x 2"	20	8.05
26I 0130	107/48012F	4" x 3"	30	4.11
26I 0140	107/48012F	6" x 4"	25	21.38

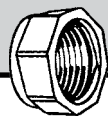

PVC/DWV FEMALE ADAPTER

SSC No.	Manuf No.	Size	Ctn	Price Each
26I 0210	101/4803	1 1/4"	75	\$ 5.31
26I 0220	101/4803	1 1/2"	50	1.05
26I 0230	101/4803	2"	50	1.78
26I 0240	101/4803	3"	20	4.79
26I 0250	101/4803	4"	10	6.14
26I 0260	101/4803	6"	10	20.61

continued on next page

PVC/DWV PLASTIC

Note: All Prices On This Page Have Changed

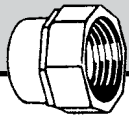

PVC/DWV FEMALE FITTING ADAPTER

SSC No.	Manuf No.	Size	Ctn	Price Each
26I 0270	105/48032	1 1/2"	65	\$ 1.32
26I 0280	105/48032	2"	35	1.71
26I 0290	105/48032	3"	25	4.81
26I 0300	105/48032	4"	10	7.90
26I 0310	105/48032	6"	5	23.01



PVC/DWV 45° STREET BEND

SSC No.	Manuf No.	Size	Ctn	Price Each
26I 0590	323/48062	1 1/4"	40	\$ 3.68
26I 0600	323/48062	1 1/2"	45	1.09
26I 0610	323/48062	2"	30	1.69
26I 0620	323/48062	3"	30	4.60
26I 0630	323/48062	4"	10	7.86
26I 0640	323/48062	6"	6	40.63

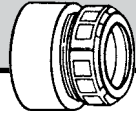

PVC/DWV TRAP ADAPTER

SSC No.	Manuf No.	Size	Ctn	Price Each
26I 0320	2850A/48017	1 1/4"	60	\$ 1.71
26I 0330	104-P/48017	1 1/2" x 1 1/4"	50	2.07
26I 0340	104-P/48017	1 1/2"	75	1.98

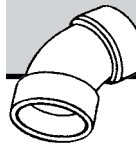

PVC/DWV 60° BEND

SSC No.	Manuf No.	Size	Ctn	Price Each
26I 0650	319/4860	1 1/2"	40	\$ 2.46
26I 0660	319/4860	2"	20	3.16
26I 0670	319/4860	3"	30	10.07
26I 0680	319/4860	4"	10	15.57

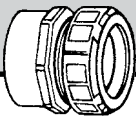

PVC/DWV FITTING TRAP ADAPTER

SSC No.	Manuf No.	Size	Ctn	Price Each
26I 0350	480127	1 1/4"	90	\$ 2.68
26I 0360	103-P	1 1/2" x 1 1/4"	75	2.22
26I 0370	103-P	1 1/2"	50	2.07

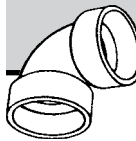

PVC/DWV 90° ELL VENT

SSC No.	Manuf No.	Size	Ctn	Price Each
26I 0690	331/4807V	1 1/2"	40	\$ 2.40
26I 0700	331/4807V	2"	30	3.15
26I 0710	331/4807V	3"	20	7.94

PVC/DWV 22 1/2° BENDS

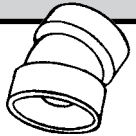

SSC No.	Manuf No.	Size	Ctn	Price Each
26I 0440	324/4808	1 1/2"	30	\$ 1.55
26I 0450	324/4808	2"	40	1.93
26I 0460	324/4808	3"	30	4.93
26I 0470	324/4808	4"	15	7.54
26I 0480	324/4808	6"	10	45.29

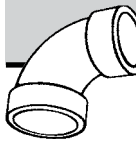

PVC/DWV 90° ELLS

SSC No.	Manuf No.	Size	Ctn	Price Each
26I 0720	300/4807	1 1/4"	50	\$ 4.11
26I 0730	300/4807	1 1/2"	75	1.13
26I 0740	300/4807	2"	25	1.78
26I 0750	300/4807	3"	30	5.24
26I 0760	300/4807	4"	10	10.33
26I 0770	300/4807	6"	5	36.25

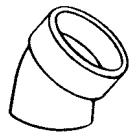

PVC/DWV 22 1/2° STREET BEND

SSC No.	Manuf No.	Size	Ctn	Price Each
26I 0490	326/48082	1 1/2"	50	\$ 4.39
26I 0500	326/48082	2"	45	4.70
26I 0510	326/48082	3"	30	7.40
26I 0520	326/48082	4"	15	10.78

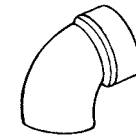

PVC/DWV 90° STREET ELL

SSC No.	Manuf No.	Size	Ctn	Price Each
26I 0780	302/48072	1 1/4"	35	\$ 5.66
26I 0790	302/48072	1 1/2"	45	1.51
26I 0800	302/48072	2"	40	2.29
26I 0810	302/48072	3"	25	5.81
26I 0820	302/48072	4"	10	10.92



PVC/DWV 45° BEND

SSC No.	Manuf No.	Size	Ctn	Price Each
26I 0530	321/4806	1 1/4"	50	\$ 2.69
26I 0540	321/4806	1 1/2"	40	1.11
26I 0550	321/4806	2"	25	1.59
26I 0560	321/4806	3"	20	4.69
26I 0570	321/4806	4"	10	8.23
26I 0580	321/4806	6"	5	33.18

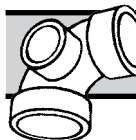

PVC/DWV LONGSWEEP 90° ELL WITH SIDE INLET

SSC No.	Manuf No.	Size	Ctn	Price Each
26I 0830	311	3" x 3" x 2"	15	\$ 28.35

PVC/DWV PLASTIC

Note: All Prices On This Page Have Changed

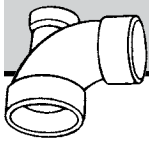

PVC/DWV 90° ELL WITH LOW HEEL INLET

SSC No.	Manuf No.	Size	Ctn	Price Each
261 0840	307	3" x 3" x 2"	25	\$ 19.73

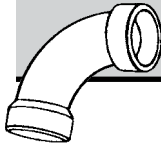

PVC/DWV 90° LONGSWEEP ELL

SSC No.	Manuf No.	Size	Ctn	Price Each
261 0850	304/4807LT	1 1/2"	55	\$ 2.71
261 0860	304/4807LT	2"	30	2.93
261 0870	304/4807LT	3"	15	6.89
261 0880	304/4807LT	4"	4	13.16

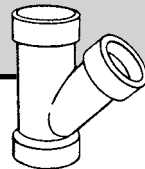

PVC/DWV 45° WYE

SSC No.	Manuf No.	Size	Ctn	Price Each
261 0890	600/4810	1 1/4"	35	\$ 5.11
261 0900	600/4810	1 1/2"	55	3.85
261 0910	600/4810	2"	25	3.66
261 0920	600/4810	3"	10	9.88
261 0930	600/4810	4"	5	17.92
261 0940	600/4810	6"	2	54.09
261 0950	601/4810	2" x 1 1/2"	35	5.16
261 0960	601/4810	3" x 1 1/2"	15	6.46
261 0970	601/4810	3" x 2"	15	7.30
261 0980	601/4810	4" x 4" x 2"	10	10.78
261 0990	601/4810	4" x 4" x 3"	10	14.54
261 1000	601/4810	6" x 6" x 4"	5	39.75

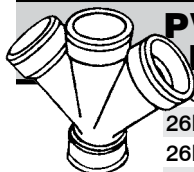

PVC/DWV DOUBLE 45° WYE

SSC No.	Manuf No.	Size	Ctn	Price Each
261 1010	611/4834	1 1/2"	40	\$ 8.34
261 1020	611/4834	2"	20	9.37
261 1030	611/4834	3"	10	19.59
261 1040	611/4834	4"	5	39.74
261 1050	612/4834	3" x 3" x 2" x 2"	20	14.60
261 1055	612/4834	4" x 4" x 2" x 2"	5	23.83
261 1060	612/4834	4" x 4" x 3" x 3"	6	31.47

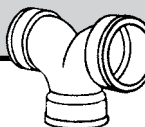

PVC/DWV 3-WAY ELL

SSC No.	Manuf No.	Size	Ctn	Price Each
261 1300	327/4837	1 1/2"	70	\$ 4.47
261 1310	327/4837	2"	35	5.89
261 1320	327/4837	3"	10	16.57

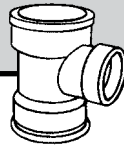

PVC/DWV SANITARY TEE

SSC No.	Manuf No.	Size	Ctn	Price Each
261 1070	400/4811	1 1/4"	25	\$ 4.12
261 1080	400/4811	1 1/2"	50	2.05
261 1090	400/4811	2"	50	3.00
261 1100	400/4811	3"	15	7.89
261 1110	400/4811	4"	12	14.02
261 1115	400/4811	6"	3	58.40
261 1120	401/4811	2" x 1 1/2" x 1 1/2"		2.64
261 1130	401/4811	2" x 1 1/2" x 2"	25	3.20
261 1140	401/4811	2" x 1 1/2"	30	2.65
261 1150	401/4811	3" x 3" x 1 1/2"	20	5.58
261 1160	401/4811	3" x 3" x 2"	20	5.89
261 1170	401/4811	4" x 4" x 2"	10	12.54
261 1180	401/4811	4" x 4" x 3"	10	17.04



PVC/DWV DOUBLE SANITARY TEE

SSC No.	Manuf No.	Size	Ctn	Price Each
261 1190	428/4835	1 1/2"	50	\$ 4.54
261 1200	428/4835	2"	25	6.13
261 1210	428/4835	3"	15	17.14
261 1220	428/4835	4"	8	27.56
261 1230	428/4835	2" x 2" x 1 1/2" x 1 1/2"		4.63
261 1240	428/4835	3" x 2"	20	10.35
261 1250	428/4835	4" x 2"	15	22.79
261 1260	428/4835	4" x 3"	10	23.39

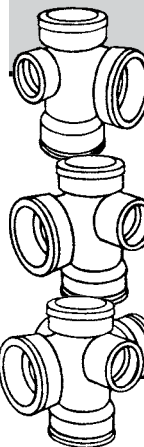

DOUBLE SANITARY TEES WITH SIDE INLETS

SSC No.	Manuf No.	Size	Ctn	Price Each
ABS DOUBLE SANITARY TEE WITH LEFT SIDE INLET				10
261 1280	416/4871	3" x 3" x 3" x 2"		\$ 14.35
ABS DOUBLE SANITARY TEE WITH RIGHT SIDE INLET				10
261 1270	417/4872	3" x 3" x 3" x 2"		\$ 14.35
ABS DOUBLE SANITARY TEE WITH RIGHT & LEFT SIDE INLET				10
261 1290	418	3" x 3" x 3" x 2" x 2"		\$ 20.66

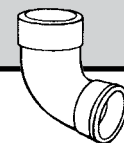

PVC/DWV CLOSET BEND

SSC No.	Manuf No.	Size	Ctn	Price Each
261 1410	330	4" x 3"	15	\$ 16.55

continued on next page

PVC/DWV PLASTIC

* Price Change

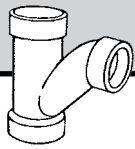

PVC/DWV WYE & 1/8 BEND COMBINATION

SSC No.	Manuf No.	Size	Ctn	Price Each
26l 1330	501	1 1/2"	50	\$ 4.93 *
26l 1340	501	2"	25	5.28 *
26l 1350	501	3"	10	13.13 *
26l 1360	501	4"	5	26.02 *
26l 1370	502	2" x 1 1/2"	20	8.64 *
26l 1380	502	3" x 2"	12	8.68 *
26l 1390	502	4" x 2"	15	14.12 *
26l 1400	502	4" x 3"	8	17.64 *



CAST IRON HUB ADAPTER

SSC No.	Manuf No.	Spigot x Hub	Ctn	Price Each
26l 1590	123-R	1 1/2" x 2"	15	\$ 7.63 *
26l 1570	123	3"	30	8.50 *
26l 1580	123	4"	50	14.87 *
26l 1600	123-R	4" x 3"	20	10.87 *

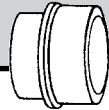

ADAPTER COUPLING

SSC No.	Manuf No.	S&D x Hub	Ctn	Price Each
26l 1610	117	4" x 3"	45	\$ 6.58 *

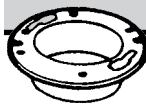

PVC/DWV CLOSET FLANGES

SSC No.	Manuf No.	Size	Hub	Ctn	Price Each
26l 1420	800	4"	Hub	25	\$ 5.69 *
26l 1430	800	4" x 3"	Hub	30	4.60 *
26l 1440	801	4" x 3"	Spig.	30	5.55 *



CLOSET FLANGE WITH METAL RING

SSC No.	Manuf No.	Size	Hub	Ctn	Price Each
26l 1450	43521	4"	Hub	30	\$ 7.47 *
26l 1460	43513	4" x 3"	Hub	30	6.76 *
26l 1470	MRSP812	4" x 3"	Spig.	35	15.53 *
26l 1475	C57-034	Over 3" Inside 4"	TKO	10.34	



PVC/DWV SLIP CAP

SSC No.	Manuf No.	Size	Hub	Ctn	Price Each
26l 1620	116	1 1/2"	Hub	90	\$ 2.24 *
26l 1630	3082/5978	2"	Hub	50	3.72 *
26l 1640	116	3"	Hub	75	6.45 *
26l 1650	116	4"	Hub	40	9.21 *

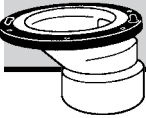

PVC/DWV OFFSET CLOSET FLANGE WITH METAL RING

SSC No.	Manuf No.	Size	Ctn	Price Each
26l 1405	43501	3" or 4"	12	\$ 13.26



PVC/DWV 2-WAY ALL HUB CLEAN-OUT

SSC No.	Manuf No.	Size	Ctn	Price Each
26l 1660	448	3"	10	\$ 18.36 *
26l 1670	448	4"	8	23.76 *

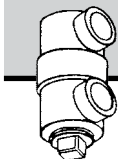

PVC/DWV DRUM TRAP CLEAN-OUT

SSC No.	Manuf No.	Size	Ctn	Price Each
26l 1480	720-X	3" x 6" x 1 1/2"	4	\$ 15.85 *

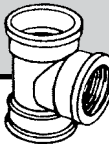

PVC/DWV CLEAN-OUT TEE LESS PLUG

SSC No.	Manuf No.	Size	Ctn	Price Each
26l 1680	445	1 1/2"	15	\$ 4.17 *
26l 1690	2115/6414	2"	30	4.86 *
26l 1700	445	3"	20	9.42 *
26l 1710	445	4"	12	16.90 *

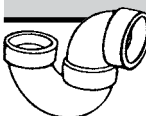

PVC/DWV P-TRAPS

SSC No.	Manuf No.	Size	Hub	Ctn	Price Each
26l 1490	706-X	1 1/2"	Hub	40	\$ 3.92 *
26l 1500	706-X	2"	Hub	20	5.28 *
26l 1510	706-X	3"	Hub	10	17.90 *
26l 1520	1853	4"	Hub	6	40.82 *

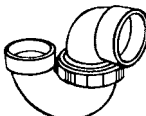

P-TRAP WITH UNION DOUBLE SEAL

SSC No.	Manuf No.	Size	Hub	Ctn	Price Each
26l 1530	708-P	1 1/2"	Hub	40	\$ 5.01 *
26l 1540	708-P	2"	Hub	25	10.87 *

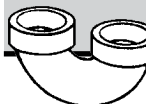

PVC/DWV RETURN BEND

SSC No.	Manuf No.	Size	Hub	Ctn	Price Each
26l 1550	700	1 1/2"	Hub	75	\$ 3.49 *
26l 1560	700	2"	Hub	30	5.99 *

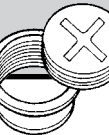

PVC TOMKAP FLUSH KIT

SSC No.	Manuf No.	Size	Price Each
26l 1800	1215C	2"	\$ 8.04
26l 1805	1325C	3"	10.87
26l 1810	1435C	4"	14.04



PVC OVERHUB REPAIR COUPLING

SSC No.	Manuf No.	Size	Ctn	Price Each
26l 3000	P22-100	1 1/2"	1	\$ 6.37
26l 3010	P22-200	2"	1	7.06
26l 3020	P22-300	3"	1	10.89
26l 3030	P22-400	4"	1	12.80

SEWER & DRAIN

*Price Change

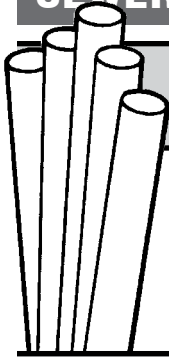

SOLID OR PERFORATED PLASTIC SEWER PIPE

SSC No.	Manuf No.	Size		Price Per Length	Price Per100'
26H 0110	2729	4" x 10' Length	Solid	\$ 11.76 *	\$ 117.60 *
26H 0210	2729	4" x 10' Length	Perforated	11.76 *	117.60 *
26H 0310	2729	6" x 10' Length	Solid	23.52 *	235.20 *

S & D TEES



SSC No.	Manuf No.	Size	Price Each
S & D TEE			
26H 0560	P-106	6"	\$ 16.35



SSC No.	Manuf No.	Size	Price Each
S & D SANITARY TEE			
26H 0510	P-156	4"	\$ 6.46

S & D BENDS



SSC No.	Manuf No.	Size	Price Each
S & D SHORT TURN QUARTER BENDS			
26H 0710	P-256	4"	\$ 4.17
26H 0730	P-206	6"	11.09

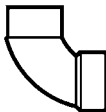

SSC No.	Manuf No.	Size	Price Each
S & D STREET QUARTER BEND			
26H 0760	P-274	4"	\$ 4.88

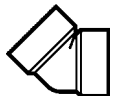

SSC No.	Manuf No.	Size	Price Each
S & D EIGHTH BENDS			
26H 1110	P-504	4"	\$ 3.06
26H 1140	P-506	6"	11.92



SSC No.	Manuf No.	Size	Price Each
S & D STREET EIGHTH BEND			
26H 0920	P-404	4"	\$ 4.10



SSC No.	Manuf No.	Size	Price Each
S & D SIXTEENTH BEND			
26H 1722	P-1704	4"	\$ 3.33

S & D 45° WYE



SSC No.	Manuf No.	Size	Price Each
26H 0810	P-304	4"	\$ 7.27
26H 0860	P-306	6"	23.47

S & D COUPLING

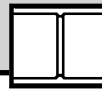

SSC No.	Manuf No.	Size	Price Each
26H 1210	P-604	4"	\$ 2.00
26H 1215	P-606	6"	7.32

S & D TO CAST IRON HUB ADAPTER



SSC No.	Manuf No.	Size	Price Each
26H 1410	P-704	4" x 4"	\$ 13.34

S & D SPIGOT TO FPT CLEANOUT ADAPTER



SSC No.	Manuf No.	Size	Price Each
S & D SPIGOT TO FPT CLEANOUT			
26H 1721	P-1504	4" x 4"	\$ 3.12

S & D PLUG



SSC No.	Manuf No.	Size	Price Each
26H 1715	P-1154	4"	\$ 2.42

S & D CAP



SSC No.	Manuf No.	Size	Price Each
26H 1723	P-1604	4"	\$ 1.76
26H 1725	P-1606	6"	6.42

SDR-35 GRAVITY SEWER PIPE & FITTINGS

*Price Change

SDR-35 GRAVITY SEWER PIPE - 14' LENGTHS

- A** LOCKED IN RUBBER SEALING RING FOR TIGHT, FLEXIBLE SEAL. RING TITE JOINT MEETS EXACTING TIGHTNESS REQUIREMENTS & THOSE OF ASTM D-3212. SIMPLIFIES ASSEMBLY.
- B** SPIGOT ENDS SUPPLIED FROM FACTORY WITH BEVEL, CUT ENDS NEED NOT BE BEVELED ON JOBSITE. SIMPLY REMOVE BURRS & ROUND THE CUT END WITH AN ORDINARY FILE.
- C** THE BELL IS AN INTEGRAL PART OF THE PIPE LENGTH WITH THE SAME STRENGTH.

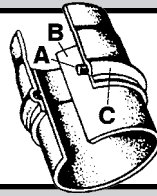
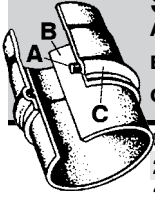

SSC No.	Manuf No.	Size	Price Ea	Per 100'
26H 2040	SDR-35	4"	\$ 20.28	\$ 144.86
26H 2045	SDR-35	6"	43.40	310.00
26H 2050	SDR-35	8"	84.00	600.00 *

SSC No.	Manuf No.	Size	Price Ea	Per 100'
26H 2060	SDR-35	10"	\$ 113.90	\$ 813.57
26H 2065	SDR-35	12"	163.54	1168.14
26H 2067	SDR-35	15"	260.68	1862.00

SDR-35 GRAVITY SEWER FITTINGS

SSC No. Manuf No. Size Price Each

SSC No. Manuf No. Size Price Each

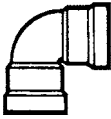

90° ELLS - BELL X BELL				
26H 2100	G-256	4" Bell x Bell	\$ 17.40	
26H 2110	G-206	6" Bell x Bell	26.07	
26H 2120	G-208	8" Bell x Bell	82.92 *	

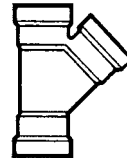

WYE - BELL X BELL X BELL				
26H 2475	G-304	4"	\$ 19.42	
26H 2480	G-306	6"	47.56	
26H 2485	G-308	8"	122.17	



90° ELLS - BELL X SPIGOT				
26H 2122	G-274	4" Bell x Spigot	\$ 18.51	
26H 2124	G-226	6" Bell x Spigot	24.70	
26H 2130	G-228	8" Bell x Spigot	74.42	

26H 2490	G-306-4	6" x 4"	39.38	
26H 2494	G-308-4	8" x 4"	57.18	
26H 2495	G-308-6	8" x 6"	70.07	



45° ELLS - BELL X BELL				
26H 2150	G-504	4" Bell x Bell	\$ 12.95 *	
26H 2160	G-506	6" Bell x Bell	26.29 *	
26H 2165	G-508	8" Bell x Bell	64.90	



PLUG				
26H 2430	G-1164	4"	\$ 5.49	
26H 2440	G-1166	6"	5.45	
26H 2450	G-1168	8"	34.32 *	



45° ELLS - BELL X SPIGOT				
26H 2210	G-404	4" Bell x Spigot	\$ 11.65 *	
26H 2215	G-406	6" Bell x Spigot	20.25	
26H 2220	G-408	8" Bell x Spigot	61.13	



CAP				
26H 2520	G-1604	4"	\$ 5.40	
26H 2530	G-1606	6"	13.63	



22 1/2° ELLS - BELL X BELL				
26H 2170	G-1704	4" Bell x Bell	\$ 11.25	
26H 2175	G-1706	6" Bell x Bell	22.16	

SADDLE TEE OR WYE WITH CLAMPS



SSC No.	Manuf No.	Size	Price Each
SADDLE TEE WITH CLAMPS			
26H 2300	136-006-4	6" x 4"	\$ 23.48
26H 2320	136-008-4	8" x 4"	38.68
26H 2310	136-008-6	8" x 6"	42.19

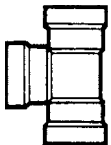

TEE - BELL X BELL X BELL				
26H 2180	G-104	4"	\$ 18.24	
26H 2185	G-106	6"	44.96 *	
26H 2190	G-108	8"	86.18	
26H 2228	G-106-4	6" x 4"	37.21	
26H 2230	G-108-4	8" x 4"	67.93 *	
26H 2240	G-108-6	8" x 6"	61.13	



SADDLE WYE WITH CLAMPS				
26H 2460	135-006-4	6" x 4"	\$ 23.92	
26H 2470	135-008-4	8" x 4"	32.24	
26H 2472	135-008-6	8" x 6"	24.78	



REPAIR COUPLING				
26H 2370	G-624	4"	\$ 12.91	
26H 2380	G-626	6"	29.67	
26H 2400	G-628	8"	45.92	

SPANNER FLANGE				
26H 2550	SF-100		\$ 9.30	

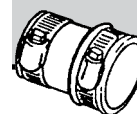

DRAIN & TRAP CONNECTOR

SSC No.	Manuf No.	Size	Price Each
26H 2560	DTC-150	1 1/2" x 1 1/4"	\$ 9.39 *
26H 2565	DTC-215	2" x 1 1/2"	7.02



MISSION COUPLINGS SADDLES

*Price Change

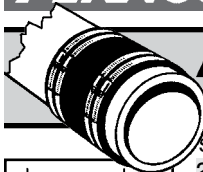

FERNCO COUPLINGS

WILL CONNECT ANY TWO PIPES WITHIN 5% +- OF THE SIZE ON CHART

SSC No.	Part No.	Size	A	B	C	Type Of Pipe	Price Each
26H 2566	1001-44	4" x 4"	5.25	5.25	4.00	Clay to Clay	\$ 7.52
26H 2567	1001-66	6" x 6"	7.52	7.52	6.00	Clay to Clay	20.99
26H 2568	1001-88	8" x 8"	9.65	9.65	6.00	Clay to Clay	32.32
26H 2570	1002-44	4" x 4"	5.25	4.38	4.00	Clay to Cast Iron or Plastic	\$ 9.10
26H 2572	1002-64	6" x 4"	7.38	4.38	6.00	Clay to Cast Iron or Plastic	22.84
26H 2573	1002-66	6" x 6"	7.38	6.38	6.00	Clay to Cast Iron or Plastic	19.46 *
26H 2574	1002-88	8" x 8"	9.65	8.50	6.00	Clay to Cast Iron or Plastic	29.89
26H 2575	1002-1010	10" x 10"	12.73	10.60	6.00	Clay to Cast Iron or Plastic	44.94
26H 2576	1002-1212	12" x 12"	14.38	12.60	6.00	Clay to Cast Iron or Plastic	48.50
26H 2577	1051-44	4" x 4"	4.75	4.38	4.00	Asbestos Cement or DI to CI or Plastic	\$ 9.10
26H 2616	1056-125	1 1/4" x 1 1/4"	1.65	1.65	3.50	CI or Plastic to CI or Plastic	\$ 4.68
26H 2617	1056-150/125	1 1/2" x 1 1/4"	1.90	1.65	3.50	CI or Plastic to CI or Plastic	5.18
26H 2619	1056-150	1 1/2" x 1 1/2"	1.90	1.90	3.50	CI or Plastic to CI or Plastic	4.77
26H 2630	1056-215	2" x 1 1/2"	2.40	1.90	3.50	CI or Plastic to CI or Plastic	5.67
26H 2578	1056-22	2" x 2"	2.40	2.40	3.50	CI or Plastic to CI or Plastic	5.38
26H 2579	1056-32	3" x 2"	3.38	2.40	4.00	CI or Plastic to CI or Plastic	6.71
26H 2580	1056-33	3" x 3"	3.38	3.38	4.00	CI or Plastic to CI or Plastic	6.93
26H 2582	1056-42	4" x 2"	4.38	2.40	4.00	CI or Plastic to CI or Plastic	12.68
26H 2585	1056-43	4" x 3"	4.38	3.38	4.00	CI or Plastic to CI or Plastic	9.80
26H 2586	1056-44	4" x 4"	4.42	4.42	4.00	CI or Plastic to CI or Plastic	9.09
26H 2590	1056-64	6" x 4"	6.38	4.38	6.00	CI or Plastic to CI or Plastic	22.84
26H 2595	1056-66	6" x 6"	6.38	6.38	6.00	CI or Plastic to CI or Plastic	19.46
26H 2600	1056-88	8" x 8"	8.50	8.50	6.00	CI or Plastic to CI or Plastic	29.90

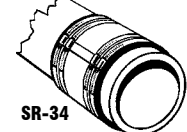
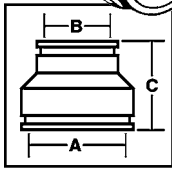
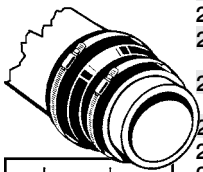

SR-34



MISSION COUPLINGS & BUSHINGS

SSC No.	Part No.	Size	Type Of Pipe	Price Each
COUPLINGS				
26K 7600	0404665/4282	4"	Clay	\$ 9.87
26K 7880	0410704	10"	Clay	44.61
26K 7630	0404723	4"	Cast Iron	\$ 13.07
26K 7650	0406801	6"	Cast Iron	17.83
BUSHINGS				
26K 8300	0504449/2346	4"	Plain End	\$ 2.73
26K 8410	0504514	4"	Thinwall Plastic	2.33
26K 8460	0506410/2510	6"	Plain End	6.53
26K 8473	0508440	8"	Asbestos Cement	11.76
26K 8475	0508432	8"	Plain End	11.76

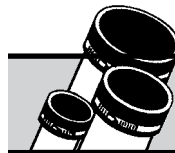

FERNCO QUICK CAPS CAP-ALL

SSC No.	Part No.	Size	Price Each
26G 0800	QC 101	1 1/2"	\$ 1.84 *
26G 0803	QC 102	2"	3.13
26G 0806	QC 103	3"	4.20
26G 0809	QC 104	4"	4.75
	QC 105	5"	Call For Price
26G 0810	QC 106	6"	4.78 *
	QC 108	8"	Call For Price

For More Information On These Products Or
On Products Not Listed, Call
Salina Supply Company At (785) 823-2221

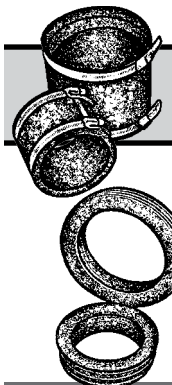

PREDCO SEWER SADDLES & DONUTS

FOR PREDCO EASY TAP SYSTEMS

SSC No.	Part No.	Size	Type Of Pipe	Price Each
26H 2761	HTS6/E	6"	Hub Tap Sewer Saddle*	With Epoxy \$ 50.95
26H 2762	614-605	6"	Fernco Dount	Schedule 40 19.78
26H 2764	HTS4/E	4"	Hub Tap Sewer Saddle*	With Epoxy \$ 44.12 *
26H 2766	490-405	4"	Fernco Dount	Schedule 40 17.03 *
26H 2768	490-401	4"	Fernco Dount	SDR 35 14.34

*Requires a Donut to make the branch connection.

continued on next page

FERNCO MISSION SPECIALTY COUPLINGS

*Price Change

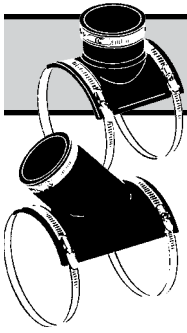

FERNCO FLEXIBLE TEE OR WYE SADDLES

ELASTOMERIC CONSTRUCTION

SSC No.	Part No.	Inlet Size			Price Each
26H 2700	S26-001/DFW4T	4"	Tee Saddle	Fits Pipe Diameter 4" Through 12"	\$ 58.54
26H 2710	S27-001/DFW4Y	4"	Wye Saddle	Fits Pipe Diameter 4" Through 12"	76.06
26H 2750	S26-002/DFW6T	6"	Tee Saddle	Fits Pipe Diameter 6" Through 12"	\$ 77.36 *
26H 2760	S27-002/DFW6Y	6"	Wye Saddle	Fits Pipe Diameter 6" Through 12"	96.86
26H 2770	224		Clamp For Wye Saddle		\$ 6.79

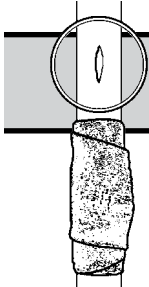

FERNCO POW-R WRAP PIPE REPAIR KIT

STRONG, PERMANENT & ECONOMICAL REPAIR • WORKS ON ALL PIPE - EVEN WET, DRY, CLEAN, DIRTY OR CORRODED PIPE
EACH KIT CONTAINS RESIN IMPREGNATED FIBERGLASS TAPE IN FOIL BAG, EPOXY PUTTY, 1 PAIR GLOVES & INSTRUCTIONS

SSC No.	Part No.	Size	For Pipe Diameter		Price Each
26H 3200	FPW248CS	1"	Up To 1" Pipe	2" x 48" Wrap	\$ 15.59
26H 3250	FPW3132CS	3"	1 1/4" To 3" Pipe	3" x 132" Wrap	32.26
26H 3300	FPW4252CS	6"	3" To 6" Pipe	4" x 252" Wrap	53.01 *

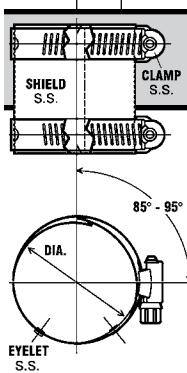

FERNCO PRO-FLEX COUPLINGS

Ssc No.	Part No.	Price Each
26K 9030	3001-22/CK-22	\$ 12.83
26K 9035	3001-33/CK-33	19.11
26K 9020	3001-115/CK-115	13.54
26K 9025	3001-215/CK-215	9.79
26K 9040	3000-33/CP-33	10.63
26K 9045	3000-43/CP-43	15.53
26K 9050	3000-44/CP-44	11.63
26K 9055	3003-150/K-150	14.63*
26K 9070	3002-150/T-150	11.43
26K 9075	3002-215/T-215	11.43

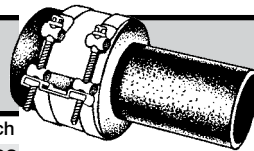

MISSION SPECIALTY COUPLINGS

Ssc No.	Part No.	Price Each
26K 9010	C-420	\$ 10.73
26K 9015	C-430	10.23
26K 9012	C-640	27.38
26K 9060	PC-32	11.27
26K 9065	PC-43	13.05
26K 9080	TWC-44	10.38
26K 9083	TWP-43	12.84
26K 9085	TWP-44	10.06

SEE CHART TO DETERMINE COUPLING NUMBER NEEDED...

	CAST IRON						PLASTIC				COPPER DWV		
	1 1/2"	2"	3"	4"	3" X.H.	6"	1 1/2"	1 1/2"	2"	3"	4" T.W.	1 1/2"	2"
PLASTIC	1 1/4"	3001-115/CK-115	3001-215/CK-215				3003-150/K-150	3001-115/CK-115	3001-215/CK-215			3003-150/K-150	
	1 1/2"							3001-115/CK-115					
	2"	C-215		C-320	C-420	PC-32		3001-215/CK-215			PC-32		
	3"		PC-32	3000-33/CP-33	3000-43/CP-43							TWP-43	
	4"			PC-43								TWP-44	
4" T.W.													
T.W. = Thin Wall													
STEEL	1 1/4"	3001-115/CK-115	3001-215/CK-215					3001-115/CK-115	3001-215/CK-215				
	1 1/2"							3001-115/CK-115					
	2"	C-215			C-420	PC-32		3001-215/CK-215			PC-32		3001-22/CK-22
3"		PC-32		3000-43/CP-43						PC-32			
COPPER DWV	1 1/4"	3001-115/CK-115	3001-215/CK-215				3003-150/K-150	3001-115/CK-115	3001-215/CK-215			3003-150/K-150	
	2"		3001-22/CK-22						3001-22/CK-22				
	3"			3001-33/CK-33									
TAILPIECE	1 1/4"		3002-215/T-215						3002-150/215/T-150/215				
	2"		C-320	C-420	PC-32		3001-215/CK-215						
CAST IRON	3"		C-320		C-430	CP-33							
	4"		C-420			3000-43/CP-43	C-640				C-420		TWC-43
	6"			C-640									
	3" X.H.		PC-32	3000-33/CP-33	3000-44/CP-44					PC-32			
4" X.H.				PC-43									
X.H. = Extra Heavy													

PVC PLASTIC PIPE • SCHEDULE 40 PVC PLASTIC FTGS

*Price Change

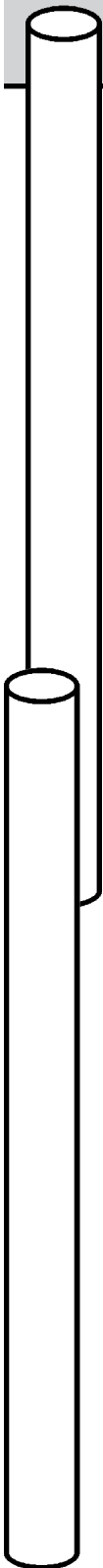

PVC PLASTIC PIPE

ALL PIPE IN 20' LENGTHS

SSC No.	Size	Price Each	Per 100'
SDR-13.5/315 • BELL END			
56B 0050	Bell End 1/2"	\$ 4.88 *	\$ 24.40 *
SDR-21/200 • BELL END OR RING-TITE			
56B 0075	Bell End 3/4"	\$ 5.46 *	\$ 27.30 *
56B 0100	Bell End 1"	7.32 *	36.60 *
56B 2522	Ring-Tite 2"	\$ 24.18 *	\$ 120.90 *
56B 2527	Ring-Tite 3"	49.27 *	246.35 *
56B 2528	Ring-Tite 4"	79.15 *	395.75 *
56B 2529	Ring-Tite 6"	157.72 *	788.60 *
SDR-26/160 • BELL END OR RING-TITE			
56B 1540	Bell End 1 1/4"	\$ 9.80 *	\$ 49.00 *
56B 1560	Bell End 1 1/2"	13.02 *	65.10 *
56B 1810	Bell End 2"	19.14 *	95.70 *
56B 1830	Bell End 2 1/2"	25.96 *	129.80 *
56B 1860	Bell End 3"	39.39 *	196.95 *
56B 1910	Bell End 4"	62.62 *	313.10 *
56B 1915	Bell End 5"	92.25 *	461.25 *
56B 1920	Bell End 6"	129.04 *	645.20 *
56B 2500	Ring-Tite 2"	\$ 19.34 *	\$ 96.70 *
56B 2510	Ring-Tite 4"	65.10 *	325.50 *
56B 2515	Ring-Tite 6"	139.83 *	699.15 *
SCHEDULE 40 • BELL END			
56B 2310	Bell End 1/2"	\$ 9.51 *	\$ 47.55 *
56B 2330	Bell End 3/4"	10.54 *	52.70 *
56B 2350	Bell End 1"	17.32 *	86.60 *
56B 2360	Bell End 1 1/4"	19.34 *	96.70 *
56B 2370	Bell End 1 1/2"	19.43 *	97.15 *
56B 2380	Bell End 2"	26.74 *	133.70 *
56B 2390	Bell End 2 1/2"	54.02 *	270.10 *
56B 2395	Bell End 3"	57.33 *	286.65 *
56B 2397	Bell End 4"	78.41 *	392.05 *
56B 2410	Bell End 6"	161.78 *	808.90 *
56B 2420	Bell End 8"	196.34 *	981.70 *
56B 2430	Bell End 10"	324.54 *	1622.70 *
56B 2440	Bell End 12"	476.24 *	2381.20 *
SCHEDULE 80 • PLAIN END OR THREADED END			
56H 0100	Plain End 1/2"	\$ 9.92	\$ 49.60
56H 0105	Plain End 3/4"	13.23	66.15
56H 0110	Plain End 1"	19.84	99.20
56H 0115	Plain End 1 1/4"	27.69	138.45
56H 0120	Plain End 1 1/2"	30.59	152.95
56H 0125	Plain End 2"	42.57	212.85
56H 0135	Plain End 3"	88.04	440.20
56H 0140	Plain End 4"	126.48	632.40
56H 0500	Threaded 1"	\$ 17.92	\$ 89.60

SCHEDULE 40 PVC PLASTIC 90° ELLS



SSC No.	Manuf. No.	Size	Ctn	Each
90° ELL • SLIP X SLIP				
56B 3310	406-005	1/2"	50	\$.36 *
56B 3360	406-007	3/4"	50	.40 *
56B 3380	406-010	1"	50	.73 *
56B 3410	406-012	1 1/4"	25	1.28 *
56B 3430	406-015	1 1/2"	25	1.38 *
56B 3450	406-020	2"	25	2.16 *
56B 3470	406-025	2 1/2"	10	6.56 *
56B 3490	406-030	3"	10	7.86 *
56B 3520	406-040	4"	8	14.05 *
56B 3550	406-060	6"	5	44.67 *

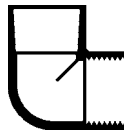

SSC No.	Manuf. No.	Size	Ctn	Each
90° ELL • SLIP X THREAD				
56B 3610	407-005	1/2"	50	\$.45 *
56B 3630	407-007	3/4"	50	.52 *
56B 3650	407-010	1"	50	.96 *
56B 3670	407-015	1 1/2"	25	1.79 *
56B 3660	407-101	3/4" x 1/2"	50	.53 *
56B 3663	407-130	1" x 1/2"	50	1.48 *



SSC No.	Manuf. No.	Size	Ctn	Each
90° STREET ELL • SPIGOT X SLIP				
56B 3671	409-005	1/2"	50	\$ 1.01 *
56B 3672	409-007	3/4"	50	1.25 *
56B 3690	409-010	1"	50	2.16 *
56B 3691	409-012	1 1/4"	25	2.58 *
56B 3692	409-015	1 1/2"	25	2.85 *
56B 3693	409-020	2"	10	5.49 *



SCHEDULE 40 PVC PLASTIC 45° ELL

SSC No.	Manuf. No.	Size	Ctn	Each
45° ELL • SLIP X SLIP				
56B 3720	417-005	1/2"	50	\$.60 *
56B 3740	417-007	3/4"	50	.92 *
56B 3760	417-010	1"	50	1.11 *
56B 3780	417-012	1 1/4"	25	1.54 *
56B 3810	417-015	1 1/2"	25	1.93 *
56B 3830	417-020	2"	10	2.52 *
56B 3850	417-025	2 1/2"	10	6.58 *
56B 3870	417-030	3"	10	10.21 *
56B 3910	417-040	4"	5	18.30 *
56B 3915	417-060	6"	8	45.21 *

continued on next page

SCHEDULE 40 PVC PLASTIC FITTINGS

Note: All Prices On This Page Have Changed

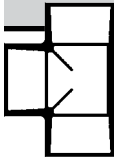
**SCHEDULE 40
PVC PLASTIC TEES**

SSC No.	Manuf. No.	Size	Ctn	Each
TEE • SLIP X SLIP				
56B 2860	401-005	1/2"	50	\$.45
56B 2880	401-007	3/4"	50	.52
56B 2910	401-010	1"	50	.96
56B 2930	401-012	1 1/4"	25	1.51
56B 2950	401-015	1 1/2"	25	1.83
56B 2970	401-020	2"	10	2.66
56B 2990	401-025	2 1/2"	10	8.78
56B 3020	401-030	3"	10	11.53
56B 3040	401-040	4"	6	20.86
56B 3060	401-060	6"	4	70.19
56B 3065	401-101	3/4" x 1/2"	50	.60
56B 3070	401-130	1" x 1/2"		1.01
56B 3078	401-211	1 1/2" x 1"	25	2.90
56B 3080	401-248	2" x 3/4"	10	2.85
56B 3082	401-249	2" x 1"	10	2.85
56B 3085	401-420	4" x 2"	10	20.86
56B 3100	401-532	6" x 4"	2	70.19

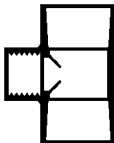
TEE • SLIP X THREAD

56B 3120	402-101	3/4" x 1/2"	50	\$.79
56B 3130	402-130	1" x 1/2"	50	1.20
56B 3140	402-248	2" x 3/4"	10	4.44

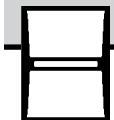
**SCHEDULE 40
PVC PLASTIC COUPLING**

SSC No.	Manuf. No.	Size	Ctn	Each
COUPLING • SLIP X SLIP				
56B 3917	429-005	1/2"	50	\$.24
56B 3918	429-007	3/4"	50	.33
56B 3919	429-010	1"	50	.57
56B 3920	429-012	1 1/4"	25	.79
56B 3921	429-015	1 1/2"	25	.84
56B 3922	429-020	2"	10	1.29
56B 3923	429-025	2 1/2"	10	2.85
56B 3924	429-030	3"	10	4.46
56B 3926	429-040	4"	6	6.44
56B 3930	429-050	5"	5	11.81
56B 3927	429-060	6"	4	20.38

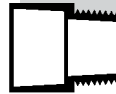
**SCHEDULE 40
PVC PLASTIC ADAPTERS**

SSC No.	Manuf. No.	Size	Ctn	Each
ADAPTER • SLIP X MALE				
56B 3950	436-005	1/2"	50	\$.33
56B 3970	436-007	3/4"	50	.36
56B 3990	436-010	1"	50	.65
56B 3991	436-102	1" x 3/4"	50	.92
56B 3992	436-131	3/4" x 1"	50	1.98
56B 4020	436-012	1 1/4"	25	.79
56B 4040	436-015	1 1/2"	25	1.05
56B 4060	436-020	2"	25	1.39
56B 4080	436-025	2 1/2"	10	4.08
56B 4110	436-030	3"	0	5.98
56B 4140	436-040	4"	5	7.62
56B 4145	436-060	6"	5	19.87

**ADAPTER • SLIP X FEMALE**

56B 4160	435-005	1/2"	50	\$.40
56B 4210	435-074	1/2" x 3/4"	50	.73
56B 4215	435-133	1" x 1 1/2"		1.93
56B 4220	435-007	3/4"	50	.52
56B 4230	435-010	1"	50	.60
56B 4250	435-012	1 1/4"	25	.92
56B 4270	435-015	1 1/2"	25	1.05
56B 4290	435-020	2"	10	1.41
56B 4295	435-025	2 1/2"	10	3.58
56B 4300	435-030	3"	10	4.82
56B 4310	435-040	4"	6	7.98
56B 4320	435-060	6"	5	29.36

**SCHEDULE 40
PVC PLASTIC BUSHINGS**

SSC No.	Manuf. No.	Size	Ctn	Each
BUSHING • SLIP X SLIP				
56B 4350	437-101	3/4" x 1/2"	50	\$.37
56B 4370	437-130	1" x 1/2"	50	.68
56B 4390	437-131	1" x 3/4"	50	.68
56B 4420	437-166	1 1/4" x 1/2"	25	.92
56B 4440	437-167	1 1/4" x 3/4"	25	.92
56B 4460	437-168	1 1/4" x 1"	25	.92
56B 4490	437-209	1 1/2" x 1/2"	25	.97
56B 4510	437-210	1 1/2" x 3/4"	25	.97
56B 4530	437-211	1 1/2" x 1"	25	.97
56B 4550	437-212	1 1/2" x 1 1/4"	25	.97
56B 4570	437-247	2" x 1/2"	10	1.61
56B 4590	437-248	2" x 3/4"	10	1.61
56B 4620	437-249	2" x 1"	10	1.61
56B 4640	437-250	2" x 1 1/4"	10	1.61
56B 4660	437-251	2" x 1 1/2"	10	1.61
56B 4710	437-292	2 1/2" x 2"	10	2.59
56B 4750	437-337	3" x 1 1/2"	10	3.81
56B 4770	437-338	3" x 2"	10	3.81

For More Information On These Products Or
On Products Not Listed, Call
Salina Supply Company At (785) 823-2221

continued on next page

SCHEDULE 40 & SCHEDULE 80 PVC PLASTIC FITTINGS

*Price Change

SCHEDULE 40 PVC PLASTIC BUSHINGS cont.

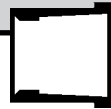

SSC No.	Manuf. No.	Size	Ctn	Each
BUSHING • SLIP X SLIP				
56B 4780	437-339	3" x 2 1/2"	10	\$ 3.81
56B 4790	437-420	4" x 2"	6	8.53
56B 4800	437-421	4" x 2 1/2"	6	8.53
56B 4820	437-422	4" x 3"	6	8.53
56B 4830	437-490	5" x 4"	5	11.99
56B 4840	437-532	6" x 4"	5	21.12
56B 4850	437-585	8" x 6"	4	73.61

BUSHING • SLIP X THREAD

56B 4870	438-101	3/4" x 1/2"	50	\$.60
56B 4890	438-130	1" x 1/2"	50	.96
56B 4910	438-131	1" x 3/4"	50	.96
56B 4930	438-168	1 1/4" x 1"	25	1.48
56B 4970	438-212	1 1/2" x 1 1/4"	25	1.71
56B 4980	438-249	2" x 1"	10	2.29
56B 5050	438-251	2" x 1 1/2"	10	2.29

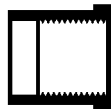

BUSHING • THREAD X THREAD

56B 5055	439-101	3/4" x 1/2"		\$ 1.05
56B 5060	439-131	1" x 3/4"		1.48
56B 5065	439-168	1 1/4" x 1"		2.20
56B 5070	439-212	1 1/2" x 1 1/4"		2.66
56B 5075	439-251	2" x 1 1/2"		3.12

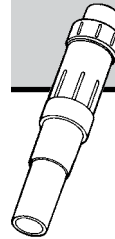

PVC PLASTIC EXPANSION COUPLING

SSC No.	Manuf. No.	Size	Ctn	Each
EXPANSION COUPLING • SLIP X SLIP				
56B 5590	117-05	1/2"	28	\$ 3.98
56B 5591	117-07	3/4"	24	4.15
56B 5592	117-10	1"	15	5.04
56B 5593	117-12	1 1/4"	10	9.32
56B 5594	117-15	1 1/2"	16	9.89
56B 5595	117-20	2"	12	16.76 *

For More Information On These Products Or
On Products Not Listed, Call
Salina Supply Company At (785) 823-2221

SCHEDULE 40 PVC PLASTIC CAP



SSC No.	Manuf. No.	Size	Ctn	Each
CAP • SLIP TYPE				
56B 5110	447-005	1/2"	50	\$.33
56B 5130	447-007	3/4"	50	.37
56B 5150	447-010	1"	50	.60
56B 5170	447-012	1 1/4"	25	.84
56B 5190	447-015	1 1/2"	25	.92
56B 5220	447-020	2"	10	1.11
56B 5240	447-025	2 1/2"	10	3.53
56B 5260	447-030	3"	10	3.86
56B 5290	447-040	4"	6	8.78
56B 5300	447-050	5"	5	14.73
56B 5310	447-060	6"	4	21.04

SCHEDULE 80 PVC PLASTIC 90° ELL

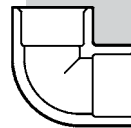

SSC No.	Manuf. No.	Size	Ctn	Each
90° ELL • SLIP X SLIP				
56H 1300	806-005	1/2"	25	\$ 1.74
56H 1305	806-007	3/4"	25	2.22
56H 1310	806-010	1"	25	3.58
56H 1315	806-012	1 1/4"	10	4.80
56H 1320	806-015	1 1/2"	10	5.14
56H 1325	806-020	2"	10	6.21
56H 1335	806-030	3"	5	16.34
56H 1340	806-040	4"	5	24.85

SCHEDULE 40 PVC PLASTIC PLUG



SSC No.	Manuf. No.	Size	Ctn	Each
PLUG • THREADED				
56B 5315	450-005	1/2"	50	\$.97
56B 5318	450-007	3/4"	50	1.05
56B 5320	450-010	1"	50	1.71

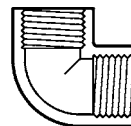

90° ELL • THREAD X THREAD

56H 1345	808-005	1/2"	20	\$ 4.03
56H 1350	808-007	3/4"	20	5.02
56H 1355	808-010	1"	10	6.32
56H 1360	808-012	1 1/4"	10	6.81
56H 1365	808-015	1 1/2"	10	9.65
56H 1370	808-020	2"	10	10.87

continued on next page

SCHEDULE 80 PVC PLASTIC FITTINGS

Note: All Prices On This Page Have Changed

SCHEDULE 80 PVC PLASTIC 45° ELL



SSC No.	Manuf. No.	Size	Ctn	Each
45° ELL • SLIP X SLIP				
56H 1400	817-005	1/2"	20	\$ 3.28
56H 1405	817-007	3/4"	10	5.01
56H 1410	817-010	1"	15	7.51
56H 1415	817-012	1 1/4"	10	9.57
56H 1420	817-015	1 1/2"	10	11.31
56H 1425	817-020	2"	10	14.66
56H 1435	817-030	3"	5	37.47
56H 1440	817-040	4"	5	67.47

SCHEDULE 80 PVC PLASTIC COUPLINGS

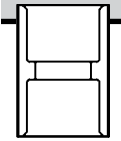

SSC No.	Manuf. No.	Size	Ctn	Each
COUPLING • SLIP X SLIP				
56H 1700	829-005	1/2"	25	\$ 3.15
56H 1705	829-007	3/4"	25	4.27
56H 1710	829-010	1"	25	4.38
56H 1715	829-012	1 1/4"	10	6.68
56H 1720	829-015	1 1/2"	10	7.20
56H 1725	829-020	2"	10	7.73
56H 1735	829-030	3"	5	21.85
56H 1740	829-040	4"	5	27.36

COUPLING • THREAD X THREAD

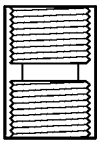

56H 1745	830-005	1/2"	25	\$ 3.53
56H 1748	830-007	3/4"	25	5.03
56H 1754	830-010	1"	15	5.40
56H 1755	830-012	1 1/4"	10	6.68
56H 1760	830-015	1 1/2"	10	14.86
56H 1765	830-020	2"	10	15.59

SCHEDULE 80 PVC PLASTIC TEE

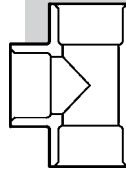

SSC No.	Manuf. No.	Size	Ctn	Each
TEE • SLIP X SLIP				
56H 1000	801-005	1/2"	25	\$ 4.91
56H 1005	801-007	3/4"	25	5.15
56H 1010	801-010	1"	25	6.44
56H 1015	801-012	1 1/4"	25	17.69
56H 1020	801-015	1 1/2"	10	17.69
56H 1025	801-020	2"	10	22.11
56H 1035	801-030	3"	5	30.06
56H 1040	801-040	4"	5	34.83

TEE • THREAD X THREAD

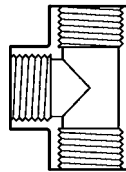

56H 1060	805-005	1/2"	20	\$ 5.68
56H 1065	805-007	3/4"	15	6.32
56H 1070	805-010	1"	15	13.95
56H 1075	805-012	1 1/4"	10	14.79
56H 1080	805-015	1 1/2"	10	17.93
56H 1085	805-020	2"	10	19.27

SCHEDULE 80 PVC PLASTIC BUSHINGS

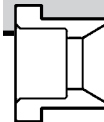

SSC No.	Manuf. No.	Size	Ctn	Each
BUSHING • SLIP X SLIP				
56H 2900	837-101	3/4" x 1/2"	25	\$ 1.02
56H 2905	837-130	1" x 1/2"	25	2.91
56H 2910	837-131	1" x 3/4"	25	2.91
56H 2915	837-166	1 1/4" x 1/2"	10	4.56
56H 2920	837-167	1 1/4" x 3/4"	10	4.56
56H 2925	837-168	1 1/4" x 1"	10	4.56
56H 2930	837-209	1 1/2" x 1/2"	10	6.21
56H 2935	837-210	1 1/2" x 3/4"	10	6.21
56H 2940	837-211	1 1/2" x 1"	10	6.21
56H 2945	837-212	1 1/2" x 1 1/4"	10	6.21
56H 2950	837-247	2" x 1/2"	10	8.86
56H 2955	837-248	2" x 3/4"	10	8.86
56H 2960	837-249	2" x 1"	10	8.86
56H 2965	837-250	2" x 1 1/4"	10	8.86
56H 2970	837-251	2" x 1 1/2"	10	8.86
56H 2995	837-336	3" x 1 1/4"	5	24.40
56H 3000	837-337	3" x 1 1/2"	5	24.40
56H 3005	837-338	3" x 2"	5	24.40
56H 3010	837-420	4" x 2"	5	33.78
56H 3015	837-422	4" x 3"	5	33.78

BUSHING • THREAD X THREAD

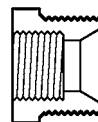

56H 3030	839-101	3/4" x 1/2"	50	\$ 3.90
56H 3040	839-131	1" x 3/4"	50	6.11
56H 3050	839-168	1 1/4" x 1"	25	6.48
56H 3060	839-212	1 1/2" x 1 1/4"	25	7.68
56H 3070	839-251	2" x 1 1/2"	10	11.25

For More Information On These Products Or
On Products Not Listed, Call
Salina Supply Company At (785) 823-2221

SCHEDULE 80 PVC PLASTIC FITTINGS

Note: All Prices On This Page Have Changed

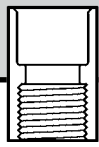

SCHEDULE 80 PVC PLASTIC ADAPTER

SSC No.	Manuf. No.	Size	Ctn	Each
ADAPTER • SLIP X FEMALE				
56H 2100	835-005	1/2"	25	\$ 2.95
56H 2105	835-007	3/4"	15	4.38
56H 2110	835-010	1"	25	6.46
56H 2115	835-012	1 1/4"	10	10.47
56H 2120	835-015	1 1/2"	10	12.83
56H 2125	835-020	2"	10	22.39
56H 2135	835-030	3"	5	39.79
56H 2140	835-040	4"	5	68.38

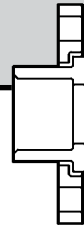

SCHEDULE 80 PVC PLASTIC FLANGE

SSC No.	Manuf. No.	Size	Ctn	Each
FLANGE • SLIP TYPE				
56H 3300	854-020	2"	15	\$15.88
56H 3305	854-030	3"	10	27.11
56H 3310	854-040	4"	6	34.29
56H 3315	854-060	6"	5	53.94

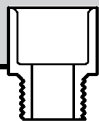

SCHEDULE 80 PVC PLASTIC ADAPTER

SSC No.	Manuf. No.	Size	Ctn	Each
ADAPTER • SLIP X MALE				
56H 2500	836-005	1/2"	25	\$ 3.69
56H 2505	836-007	3/4"	25	4.06
56H 2510	836-010	1"	25	7.03
56H 2515	836-012	1 1/4"	10	8.22
56H 2520	836-015	1 1/2"	10	11.81
56H 2525	836-020	2"	5	17.07
56H 2535	836-030	3"	5	21.55
56H 2540	836-040	4"	5	38.34

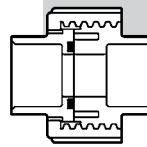

SCHEDULE 80 PVC PLASTIC UNION

SSC No.	Manuf. No.	Size	Ctn	Each
UNION • SLIP X SLIP				
56H 4000	857-005	1/2"	10	\$ 6.46
56H 4005	857-007	3/4"	10	8.21
56H 4010	857-010	1"	10	9.37
56H 4015	857-012	1 1/4"	10	18.61
56H 4020	857-015	1 1/2"	10	21.07
56H 4025	857-020	2"	10	28.57



SCHEDULE 80 PVC PLASTIC PLUG

SSC No.	Manuf. No.	Size	Ctn	Each
PLUG • THREADED TYPE				
56H 3100	850-005	1/2"	25	\$ 2.97
56H 3105	850-007	3/4"	25	3.09
56H 3110	850-010	1"	15	3.78
56H 3115	850-012	1 1/4"	10	5.57
56H 3120	850-015	1 1/2"	10	6.77
56H 3125	850-020	2"	10	6.95



SCHEDULE 80 PVC PLASTIC NIPPLES

SSC No.	Manuf. No.	Size	Ctn	Each
NIPPLES • SLIP X SLIP				
56H 5000	882-005	1/2" x Close	25	\$ 1.12
56H 5020	882-020	1/2" x 2"	25	1.20
56H 5030	882-030	1/2" x 3"	25	1.35
56H 5040	882-040	1/2" x 4"	25	1.52
56H 5050	882-050	1/2" x 5"	25	1.76
56H 5060	882-060	1/2" x 6"	25	1.85
56H 5070	883-005	3/4" x Close	25	1.20
56H 5080	883-020	3/4" x 2"	25	1.20
56H 5090	883-030	3/4" x 3"	25	1.35
56H 5100	883-040	3/4" x 4"	25	1.58
56H 5110	883-050	3/4" x 5"	25	1.85
56H 5120	883-060	3/4" x 6"	25	2.31
56H 5130	884-020	1" x 2"	25	1.76
56H 5140	884-060	1" x 6"	25	3.16
56H 5150	885-020	1 1/4" x 2"	25	2.37
56H 5160	885-060	1 1/4" x 6"	25	3.95
56H 5170	886-020	1 1/2" x 2"	25	2.77
56H 5180	885-060	1 1/2" x 6"	25	4.73
56H 5190	887-030	2" x 3"	25	3.95
56H 5200	887-060	2" x 6"	25	5.56



SCHEDULE 80 PVC PLASTIC CAPS

SSC No.	Manuf. No.	Size	Ctn	Each
CAP • SLIP TYPE				
56H 3600	847-005	1/2"	25	\$ 3.09
56H 3605	847-007	3/4"	25	3.25
56H 3610	847-010	1"	25	5.78
56H 3615	847-012	1 1/4"	10	6.97
56H 3620	847-015	1 1/2"	10	6.97
56H 3625	847-020	2"	10	13.75
56H 3635	847-030	3"	5	32.87
56H 3640	847-040	4"	5	55.42

BREAKAWAY TUBE NIPPLE • SLIP X SLIP

56H 5125	883-120	3/4" x 12"	1	\$ 3.49
----------	----------------	------------	---	---------

continued on next page

PVC PLASTIC

*Price Change

PVC PLASTIC GASKET-TYPE FITTINGS

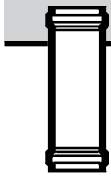

SSC No.	Manuf. No.	Size	Price Each
REPAIR COUPLING GASKET X GASKET			
56B 2540	654-020	2"	\$ 16.80
56B 2541	654-025	2 1/2"	18.48
56B 2542	654-030	3"	23.12
56B 2544	654-040	4"	41.60
56B 2545	654-050	5"	67.91
56B 2546	654-060	6"	73.10
56B 2548	654-080	8"	150.56



SSC No.	Manuf. No.	Size	Price Each
90° ELL GASKET X GASKET			
56B 2560	661-020	2"	\$ 21.98
56B 2562	661-030	3"	31.79
56B 2564	661-040	4"	54.32
56B 2566	661-060	6"	99.69
56B 2568	661-080	8"	194.45



SSC No.	Manuf. No.	Size	Price Each
45° ELL GASKET X GASKET			
56B 2570	662-020	2"	\$ 21.98
56B 2574	662-040	4"	54.32
56B 2576	662-060	6"	99.69
56B 2577	662-080	8"	194.45

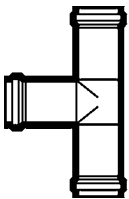

SSC No.	Manuf. No.	Size	Price Each
TEE GASKET X GASKET X GASKET			
56B 2580	658-020	2"	\$ 41.33
56B 2582	658-030	3"	48.54
56B 2584	658-040	4"	74.84
56B 2586	658-060	6"	167.60
56B 2587	658-080	8"	296.15
56B 2588	660-338	3" x 2"	48.54
56B 2590	660-420	4" x 2"	74.84
56B 2592	660-528	6" x 2"	167.60
56B 2594	660-532	6" x 4"	167.60
56B 2598	660-585	8" x 6"	289.50

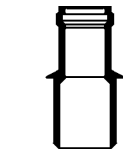

SSC No.	Manuf. No.	Size	Price Each
REDUCING BUSHING P.E. X GASKET			
56B 2604	665-420	4" x 2"	\$ 31.22
56B 2606	665-422	4" x 3"	32.69
56B 2608	665-532	6" x 4"	89.88
56B 2625	665-585	8" x 6"	152.58

PVC PLASTIC CLEANERS



SSC No.	Manuf. No.	Size	Price Each
CLEAR PVC ALL PURPOSE CLEANER			
56B 8610	30750	1/4 Pint	\$ 3.25 *
56B 8620	30751	1/2 Pint	5.85
56B 8630	30752	1 Pint	8.47



SSC No.	Manuf. No.	Size	Price Each
PURPLE PVC PRIMER/CLEANER			
56B 8650	30780	1/4 Pint	\$ 4.35
56B 8652	30783	1/2 Pint	6.52
56B 8654	30796	1 Pint	7.16
56B 8656	30806	1 Quart	13.35

PVC PLASTIC COMPRESSION FITTINGS

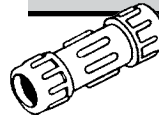

SSC No.	Manuf. No.	Size	Price Each
SCHEDULE 40 COUPLING COMPR. X COMPR.			
56B 5500	110-05	1/2"	\$ 2.80
56B 5501	110-07	3/4"	4.10
56B 5502	110-10	1"	5.55 *
56B 5503	110-12	1 1/4"	8.15
56B 5504	110-15	1 1/2"	8.43
56B 5505	110-20	2"	11.65 *
56B 5511	110-25	2 1/2"	20.65
56B 5519	110-30	3"	26.15
56B 5520	110-40	4"	44.42
56B 5521	110-60	6"	92.15

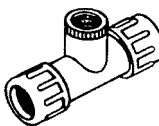

SSC No.	Manuf. No.	Size	Price Each
SCHEDULE 40 TEE COMPR. X FEMALE			
56B 5525	120-05	1/2"	\$ 4.37
56B 5530	120-07	3/4"	6.47
56B 5535	120-10	1"	7.21
56B 5540	120-12	1 1/4"	10.31
56B 5545	120-15	1 1/2"	11.69



SSC No.	Manuf. No.	Size	Price Each
SCHEDULE 40 ADAPTER COMPR. X MALE			
56B 5560	130-05	1/2"	\$ 2.82
56B 5565	130-07	3/4"	3.15
56B 5570	130-10	1"	4.06
56B 5575	130-12	1 1/4"	6.32
56B 5580	130-15	1 1/2"	6.42
56B 5585	130-20	2"	7.95

PVC PLASTIC CEMENTS



SSC No.	Manuf. No.	Size	Price Each
CLEAR PVC CEMENT MEDIUM OR HEAVY DUTY			
56B 8520	31017	1/4 Pint Med.	\$ 4.52
56B 8560	31018	1/2 Pint Med.	7.01
56B 8570	31019	1 Pint Med.	8.36
56B 8590	31020	1 Quart Med.	14.59
56B 8600	30876	1 Pint H.D.	12.94



SSC No.	Manuf. No.	Size	Price Each
CLEAR ALL PURPOSE CEMENT			
56B 8666	30818	1/4 Pint	\$ 5.00
56B 8670	30821	1/2 Pint	8.11
56B 8680	30834	1 Pint	16.19
56B 8681	30847	1 Quart	22.82

SSC No.	Manuf. No.	Size	Price Each
BLUE RAIN-R-SHINE CEMENT			
56B 8685	30893	1 Pint	\$ 12.50

SSC No.	Manuf. No.	Size	Price Each
CLEAR ALL WEATHER CEMENT			
56B 8700	31132	1 Pint	\$ 13.19

SSC No.	Manuf. No.	Size	Price Each
PLUMB R' WELL CEMENT			
56B 8750	10989 737	Quart	\$ 14.69
56B 8770	10990 737	Pint	5.20

SSC No.	Manuf. No.	Size	Price Each
1 STEP CPVC CEMENT			
56B 8720	31911	1/2 Pint	\$ 10.36

PLASTIC PIPE & FITTINGS

*Price Change



Eagle Plastics, Inc. PROGUARD POLYETHYLENE COLD WATER PIPE COILS



SSC No.	Manuf No.	Nominal Size	Nominal I.D.	O.D.	Minimum Wall	Wgt. Per Ft.	Coil Length	Price Per Coil	Price Per 100'
PROGUARD 80 PSI • SIDR-19 • IPS-ID • ASTM D-2239 • NSF-PW									
32C 0080	BFJ8C1	2"	2.067	2.285	.109	.328	100'	\$ 126.80	\$ 126.80

For More Information On These Products Or On Products Not Listed,
Call *Salina Supply Company* At (785) 823-2221



Eagle Plastics, Inc. POLYETHYLENE COLD WATER PIPE COILS



SSC No.	Manuf No.	Nominal Size	Nominal I.D.	O.D.	Minimum Wall	Wgt. Per Ft.	Coil Length	Price Per Coil	Price Per 100'
EAGLE HIGH DENSITY "3408" ASTM D2239 • SIDR-15 • 100 PSI @ 73.4°F									
32C 0100	3408	3/4"	0.824	0.944	.060	.074	100'	\$ 25.80 *	\$ 25.80 *
32C 0105	3408	3/4"	0.824	0.944	.060	.074	400'	103.20 *	25.80 *
32C 0110	3408	1"	1.049	1.189	.070	.190	100'	37.20 *	37.20 *
32C 0115	3408	1"	1.049	1.189	.070	.190	300'	111.60 *	37.20 *
32C 0120	3408	1 1/4"	1.380	1.564	.092	.187	100'	65.40	65.40
EAGLE HIGH DENSITY "3408" ASTM D2239 • SIDR-11.5 • 125 PSI @ 73.4°F									
32C 0125	3408	1/2"	0.622	0.742	.060	.057	100'	\$ 21.20 *	\$ 21.20 *
32C 0130	3408	1/2"	0.622	0.742	.060	.057	400'	84.80 *	21.20 *
32C 0140	3408	3/4"	.824	.968	.072	.090	100'	31.80 *	31.80 *
32C 0150	3408	3/4"	.824	.968	.072	.090	400'	127.20 *	31.80 *
32C 0160	3408	1"	1.049	1.231	.091	.143	100'	49.00	49.00
32C 0170	3408	1"	1.049	1.231	.091	.143	300'	147.00	49.00
32C 0180	3408	1 1/4"	1.380	1.620	.120	.249	100'	89.40	89.40
32C 0190	3408	1 1/4"	1.380	1.620	.120	.249	300'	268.20	89.40
32C 0200	3408	1 1/2"	1.610	1.890	.140	.331	100'	167.00	167.00
32C 0210	3408	1 1/2"	1.610	1.890	.140	.331	250'	417.50 *	167.00 *
32C 0220	3408	2"	2.067	2.427	.180	.542	100'	266.00	266.00
PURE-CORE "3408" LIGHT BLUE ASTM D2737 • SIDR-9 • 200 PSI @ 73.4°F									
32C 0230	PE3408	3/4" IP	.681	.875	.097	.103	100'	\$ 60.80	\$ 60.80
32C 0240	PE3408	3/4" IP	.681	.875	.097	.103	400'	240.00	60.00
32C 0250	PE3408	1" IP	.875	1.125	.125	.170	100'	96.00	96.00
32C 0260	PE3408	1" IP	.875	1.125	.125	.170	300'	288.00	96.00
32C 0270	PE3408	1 1/4" IP	1.069	1.375	.153	.254	100'	168.60 *	168.60 *
32C 0280	PE3408	3/4" Copper	.681	.875	.097	.103	100'	\$ 40.40 *	\$ 40.40 *
32C 0290	PE3408	3/4" Copper	.681	.875	.097	.103	400'	161.60 *	40.40 *
32C 0300	PE3408	1" Copper	.875	1.125	.125	.170	100'	67.00 *	67.00 *
32C 0310	PE3408	1" Copper	.875	1.125	.125	.170	300'	201.00 *	67.00 *

continued on next page

PLASTIC PIPE & FITTINGS**NYLON INSERT
MIP ADAPTER**

SSC No.	Manuf. No.	Size	Price Each
34J 0010	I11-001	1/2"	\$ 1.18
34J 0020	I11-002	3/4"	1.15
34J 0030	I11-003	1"	1.45
34J 0040	I11-004	1 1/4"	3.07
34J 0050	I11-005	1 1/2"	3.01
34J 0060	I11-006	2"	5.69

**STEEL INSERT
MIP ADAPTER**

SSC No.	Manuf. No.	Size	Price Each
34J 1010	I12-001	1/2"	\$ 3.21
34J 1020	I12-002	3/4"	3.90
34J 1030	I12-003	1"	4.79
34J 1040	I12-004	1 1/4"	6.53
34J 1050	I12-005	1 1/2"	8.23
34J 1060	I12-006	2"	11.63

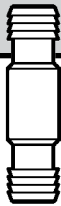
**NYLON INSERT
COUPLING**

SSC No.	Manuf. No.	Size	Price Each
34J 0110	I11-007	1/2"	\$ 1.18
34J 0120	I11-008	3/4"	1.03
34J 0130	I11-009	1"	1.34
34J 0140	I11-010	1 1/4"	2.47
34J 0150	I11-011	1 1/2"	5.67
34J 0160	I11-012	2"	6.47

**STEEL INSERT
COUPLING**

SSC No.	Manuf. No.	Size	Price Each
34J 1120	I12-014	3/4"	\$ 3.63
34J 1130	I12-015	1"	4.85
34J 1140	I12-016	1 1/4"	7.05

**NYLON INSERT
90° ELL**

SSC No.	Manuf. No.	Size	Price Each
34J 0210	I11-013	1/2"	\$ 2.12
34J 0220	I11-014	3/4"	2.78
34J 0270	I11-015	1"	3.00
34J 0280	I11-016	1 1/4"	5.14
34J 0290	I11-017	1 1/2"	7.53
34J 0310	I11-018	2"	12.54

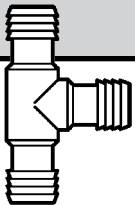
**NYLON INSERT
TEE**

SSC No.	Manuf. No.	Size	Price Each
34J 0340	I11-019	1/2"	\$ 2.74
34J 0350	I11-020	3/4"	2.96
34J 0360	I11-021	1"	3.56
34J 0370	I11-022	1 1/4"	8.66
34J 0380	I11-023	1 1/2"	11.62
34J 0390	I11-024	2"	15.05

For More Information On These Products Or
On Products Not Listed, Call
Salina Supply Company At (785) 823-2221

continued on next page

PLASTIC PIPE & FITTINGS



BRASS INSERT COUPLING

SSC No.	Manuf. No.	Size	Price Each
34I 0008	I13-015	1/2"	\$ 7.99
34I 0010	I13-016	3/4"	10.67
34I 0020	I13-017	1"	13.82
34I 0030	I13-018	1 1/4"	23.61
34I 0040	I13-019	1 1/2"	24.70
34I 0050	I13-020	2"	31.50



BRASS INSERT FIP ADAPTER

SSC No.	Manuf. No.	Size	Price Each
34I 0170	I13-009	1/2"	\$ 10.00
34I 0180	I13-010	3/4"	9.50
34I 0190	I13-011	1"	18.04
34I 0210	I13-012	1 1/4"	18.17



BRASS INSERT MIP ADAPTER

SSC No.	Manuf. No.	Size	Price Each
34I 0080	I13-001	1/2"	\$ 8.01
34I 0090	I13-002	3/4"	8.34
34I 0110	I13-003	1"	13.16
34I 0120	I13-004	1 1/4"	19.78
34I 0130	I13-005	1 1/2"	26.15
34I 0140	I13-006	2"	39.95
34I 0160	I13-007	1" x 3/4"	9.53

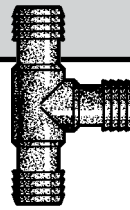

BRASS INSERT TEE

SSC No.	Manuf. No.	Size	Price Each
34I 0260	I13-021	3/4"	\$ 15.93
34I 0270	I13-022	1"	21.14

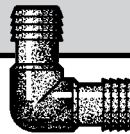

BRASS INSERT 90° ELL

SSC No.	Manuf. No.	Size	Price Each
34I 0330	I13-024	3/4"	\$ 14.59
34I 0340	I13-025	1"	15.06
34I 0350	I13-026	1 1/4"	27.89

For More Information On These Products Or On Products Not Listed,
Call *Salina Supply Company* At (785) 823-2221

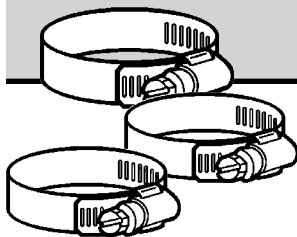

STAINLESS STEEL CLAMPS

SSC No.	Manuf. No.	Size	Price Each
34J 1270	G11-012/6712	1/2" to 1 1/4"	\$ 1.59
34J 1280	G11-020/6720	3/4" to 1 3/4"	1.59
34J 1290	G11-024/6724	1" to 2"	1.59
34J 1310	G11-036/6736	1 1/2" to 2 1/2"	1.66

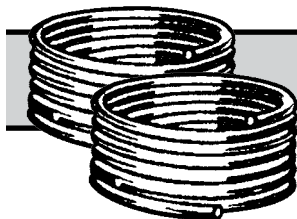

COLD WATER POLYETHYLENE TUBING

SSC No.	Manuf. No.	OD x Lgth	Price Each
58F 0910	T25-250	1/4" x 100'	\$ 32.86
58F 0960	T25-375	3/8" x 100'	34.66
58F 1010	T25-500	1/2" x 100'	35.81
58F 1060	T25-625	5/8" x 100'	58.32
58F 2000	MV4040M	1/4" x 1000'	\$ 118.54
58F 2500	MV6062M	3/8" x 1000'	304.82

continued on next page

PLASTIC PIPE & FITTINGS

*Price Change

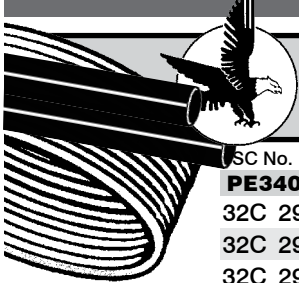

**Eagle
Plastics, Inc.**

ASTM-D TRI-STRIP BLACK GAS PIPE

• SUPERIOR RESISTANCE TO ADVERSE SOIL CONDITIONS • 100 PSI @ 73.4°F
• HIGHLY VISIBLE YELLOW STRIPES

SSC No.	Manuf. No.	Size	Length Of Coil	Price Each	Per 100'
PE3408 • SDR11 • 500' COIL					
32C 2905	2513	1"	500'	\$ 350.00 *	\$ 70.00 *
32C 2900	2513	1 1/4"	500'	550.00 *	110.00 *
32C 2915	2513	2"	500'	1030.00 *	206.00 *

**SOCKET FUSION
COUPLING FOR GAS**

SSC No.	Size	Price Each
34M 0500	1"	\$ 4.80
34M 0520	1 1/4"	4.59
34M 0540	2"	7.44

**SOCKET FUSION
90° ELL FOR GAS**

SSC No.	Size	Price Each
34M 0560	1 1/4"	\$ 9.70
34M 0580	2"	17.21

**SOCKET FUSION
TEE FOR GAS**

SSC No.	Size	Price Each
34M 0600	1 1/4"	\$ 12.94
34M 0620	2"	21.10

**TRANSITION
SERVICE RISER**

SSC No.	Manuf. No.	IPS	Price Each
34M 1900	RISER-16-30	1"	\$ 101.66 *
34M 1920	RISER-20-30	1 1/4"	145.30 *
34M 1960	RISER-32-36	2" MPT x IPS	\$ 294.05

ADAPTER WITH STIFFENER FOR GAS

SSC No.	Manuf. No.	Size	SDR	Type	Price Each
34M 1080	TRANS-20	1 1/4"	SDR 10	Compression x IPM	\$ 130.25
34M 1060	TRANS-16	1" IPS	SDR 11	Compression x IPM	96.04
34M 1100	TRANS-32	2" IPS	SDR 11	Compression x IPM	188.85



COUPLING WITH STIFFENER FOR GAS

SSC No.	Manuf. No.	Size	SDR	Type	Price Each
34M 1000	PECPL-16	1" IPS	SDR 11	Compression x Compression	\$ 41.91
34M 1020	661-1212	1 1/4"	SDR 11	Compression x Compression	56.05
34M 1040	661-0003	2"	SDR 11	Compression x Compression	143.63

For More Information On These Products Or On Products Not Listed,
Call *Salina Supply Company* At (785) 823-2221

Viega POLYETHYLENE FTGS VANEX PEX 

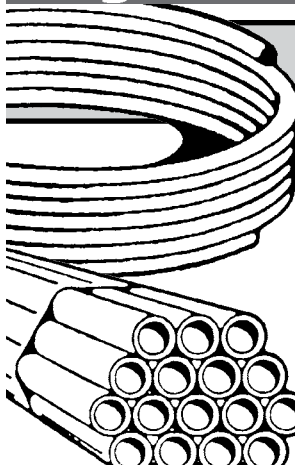
*Price Change



VANEX PEX HOT/COLD WATER TUBING

CROSSLINKED POLYETHYLENE • CTS-OD COILS OR 20' STRAIGHT LENGTHS
100 PSI @180°F • 160PSI @ 73°F ° SDR-9 • ASTM F-877

SSC No.	Manuf No.	Nom	OD	Min Wall	Size	Wgt/Lbs	Price Each	Price Per 100'
32E 1000	32021	1/2"	5/8"	.070	100' Coil	5.35	\$ 36.96	\$ 36.96
32E 1100	32020	1/2"	5/8"	.070	1000' Coil	53.50	369.61	36.96
32E 1200	32041	3/4"	7/8"	.097	100' Coil	10.23	67.06	67.06
32E 1300	32045	3/4"	7/8"	.097	500' Coil	51.91	335.22	67.06
32E 1400	32061	1"	1.125"	.125	100' Coil	16.92	174.49	174.49
32E 1500	PX6C1	1 1/4"	1.375"	.155	100' Coil	16.92	299.95	299.95
32E 0260	32011	1/4"	3/8"	.062	100'	2.6	\$ 44.73	\$ 44.73
32E 0270	33020	1/2"	5/8"	.070	20' Lgth	5.40	\$ 7.39	\$ 36.95
32E 0300	33045	3/4"	7/8"	.097	20' Lgth	10.30	13.41	67.05
32E 0325	33061	1"	1.125"	.125	20' Lgth	17.09	34.90	174.50

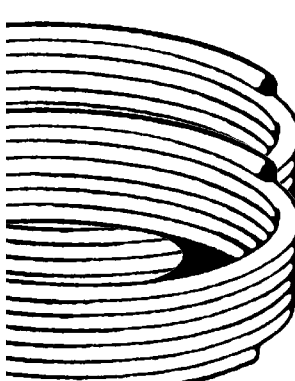

VANEX PLUS+ RED (HOT) OR BLUE (COLD) WATER TUBING

CROSSLINKED POLYETHYLENE • CTS-OD COILS
100 PSI @180°F • 160PSI @ 73°F ° SDR-9 • ASTM F-876/877

SSC No.	Manuf No.	Nom	OD	Min Wall	Size	Wgt/Lbs	Price Each	Price Per 100'
VANEX PLUS+ RED HOT WATER TUBING (COLOR CODED FOR HOT WATER)								
32E 1025	32121	1/2"	5/8"	.070	100' Coil	26.8	\$ 36.96	\$ 36.96
32E 1050	32125	1/2"	5/8"	.070	500' Coil	26.8	184.81	36.96
32E 1325	PXR4C1	3/4"	7/8"	.097	100' Coil		67.06	67.06
VANEX PLUS+ BLUE COLD WATER TUBING (COLOR CODED FOR COLD WATER)								
32E 1065	32221	1/2"	5/8"	.070	100' Coil	26.8	\$ 36.96	\$ 36.96
32E 1075	32225	1/2"	5/8"	.070	500' Coil	26.8	184.81	36.96
32E 1350	PXB4C1	3/4"	7/8"	.097	100' Coil		67.06	67.06

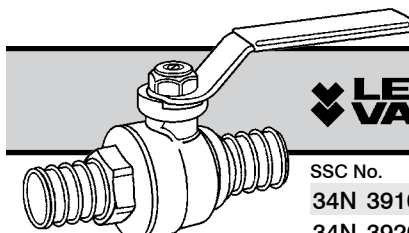

LEGEND PEX END BALL VALVES

400 W.O.G. - 150 W.S.P. • CONVENTIONAL PORT • FORGED BRASS BODY • TEFLON SEATS

SSC No.	Manuf No.	Nom	CV Factor		Price Each
34N 3910	101-585	1/2"	7.4	Pex Barb x Pex Barb	\$ 8.89 *
34N 3920	101-586	3/4"	13.4	Pex Barb x Pex Barb	12.09 *
34N 3930	101-587	1"	27.0	Pex Barb x Pex Barb	16.09 *

For More Information On These Products Or
On Products Not Listed, Call
Salina Supply Company At (785) 823-2221

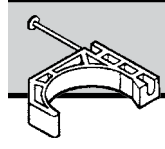

J-CLAMP TUBE CLAMP WITH NAILS

SSC No.	Manuf No.	Size	Price Each
34N 4570	H112	1/2"	\$.13
34N 4590	H134	3/4"	.18

continued on next page

Viega POLYETHYLENE FTGS VANEX PEX

*Price Change



BLACK COPPER CRIMP RING

VANEX PEX

SSC No.	Manuf No.	Size	Price Each
34N 5000	43600	3/8"	\$.22
34N 5050	43620	1/2"	.22
34N 5100	43640	3/4"	.29
34N 5110	43660	1"	.45
34N 5120	XLCR6	1 1/4"	1.08

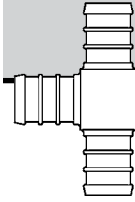

BRASS PEX INSERT TEE

CRIMP X CRIMP X CRIMP

VANEX PEX

SSC No.	Manuf No.	Size	Price Each
34N 5500	40520	1/2" x 1/2" x 1/2"	\$ 1.68 *
34N 5550	48433	3/4" x 1/2" x 1/2"	2.59 *
34N 5600	48434	3/4" x 1/2" x 3/4"	2.59 *
34N 5650	48443	3/4" x 3/4" x 1/2"	2.59 *
34N 5700	40540	3/4" x 3/4" x 3/4"	2.59 *
34N 5720	40560	1" x 1" x 1"	6.43 *
34N 5725	48553	1" x 1" x 1/2"	4.76 *
34N 5730	48544	1" x 3/4" x 3/4"	6.43 *
34N 5740	48554	1" x 1" x 3/4"	6.43 *



INSERT COUPLER

CRIMP X CRIMP

VANEX PEX

SSC No.	Manuf No.	Size	Price Each
34N 5150	40433	1/2" x 1/2"	\$.73 *
34N 5200	40443	3/4" x 1/2"	1.66 *
34N 5250	40444	3/4" x 3/4"	.91 *
34N 5260	40455	1" x 1"	1.71 *
34N 5265	404C54	1" x 3/4"	1.84 *
34N 5270	XAC66	1 1/4" x 1 1/4"	10.28



PEX INSERT ADAPTER

CRIMP X MPT ADAPTER

VANEX PEX

SSC No.	Manuf No.	Size	Price Each
34N 5750	48321	1/2" x 1/2"	\$ 1.92 *
34N 5800	48324	1/2" x 3/4"	2.88 *
34N 5850	48340	3/4" x 3/4"	2.84 *
34N 5860	48366	1" x 1"	4.78 *
34N 5870	60570	1 1/4" x 1 1/4"	8.82

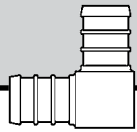

BRASS INSERT ELBOW

CRIMP X CRIMP

VANEX PEX

SSC No.	Manuf No.	Size	Price Each
34N 5300	48233	1/2" x 1/2"	\$ 1.32 *
34N 5350	48243	3/4" x 1/2"	2.86 *
34N 5400	48244	3/4" x 3/4"	1.60 *
34N 5425	48255	1" x 1"	4.34 *

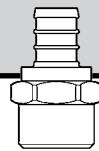

PEX INSERT ADAPTER

CRIMP X FPT ADAPTER

VANEX PEX

SSC No.	Manuf No.	Size	Price Each
34N 5900	48333	1/2" x 1/2"	\$ 2.93 *
34N 5950	48334	1/2" x 3/4"	4.59 *
34N 6000	48344	3/4" x 3/4"	3.32 *

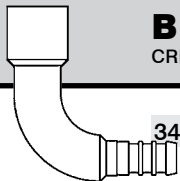

BRASS INSERT ELBOW

CRIMP X MALE

VANEX PEX

SSC No.	Manuf No.	Size	Price Each
34N 5475	44320	1/2" x 1/2"	\$ 2.94 *

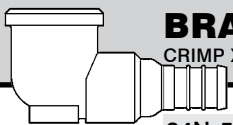

BRASS DROP EAR ELL

CRIMP X FPT

VANEX PEX

SSC No.	Manuf No.	Size	Price Each
34N 5450	40233	1/2" x 1/2"	\$ 4.81 *



PEX INSERT ADAPTER

CRIMP X MALE SWEAT ADAPTER

VANEX PEX

SSC No.	Manuf No.	Size	Price Each
34N 6050	40633	1/2" x 1/2"	\$.99 *
34N 6100	40644	3/4" x 3/4"	1.77 *

continued on next page

Viega POLYETHYLENE FTGS VANEX PEX

*Price Change



BRASS TEST PLUG

	SSC No.	Manuf No.	Size	Price Each
	34N 6150	40723	1/2"	\$.86 *
VANEX PEX	34N 6200	40744	3/4"	1.24 *

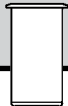

INSERT STIFFENER

STAINLESS STEEL

	SSC No.	Manuf No.	OD Size	Price Each
	34N 6250	56110	1/2" For 3/8" Pex	\$.66 *
VANEX PEX	34N 6300	56120	5/8" For 1/2" Pex	.66 *



TRANSITION COUPLING

SDR11PB X SDR9 PEX • INSERT X INSERT

	SSC No.	Manuf No.	Size	Price Each
	34N 6350	48633	1/2"	\$.85 *
VANEX PEX	34N 6400	48644	3/4"	1.24 *

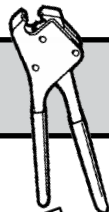

COMPACT CRIMPMAKER™

FULL CIRCLE CRIMP MAKING TOOL WITH GO/NO GO CALIPER INCLUDED

	SSC No.	Manuf No.	Size	Price Each
	34N 7060	41723	1/2"	\$ 181.26 *
	34N 9060	41744	3/4"	201.40 *



SOFT-TOUCH™ CRIMP TOOL

FULL CIRCLE CRIMP MAKING TOOL WITH GO/NO GO CALIPER INCLUDED

	SSC No.	Manuf No.	Size	Price Each
	34N 9070	41760	1"	\$ 289.33

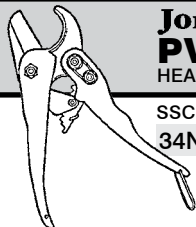

Jones Stephens Corp. PVC PIPE CUTTER

HEAVY DUTY

	SSC No.	Manuf No.	Size	Price Each
	34N 9020	P70-018	1 1/4"	\$ 58.03



FERRULE FOR RISERS

	SSC No.	Manuf No.	Size	Price Each
	34N 3430	53005	3/8"	\$.14 *
	34N 3450	53015	1/2"	.31 *
	34N 3470	53020	5/8"	.20 *



LAVATORY RISER

ONE PIECE UNI-CONE RISER WITH LOOSE FERRULE

	SSC No.	Manuf No.	Size	Price Each
	20J 8700	58112	3/8" x 12"	\$.78 *
	20J 8720	58120	3/8" x 20"	.99 *
	20J 8740	58130	3/8" x 30"	1.35 *



ACETAL LAVATORY CENTERSET NUT

	SSC No.	Manuf No.	Size	Price Each
	20J 8760	33704	3/8"	\$ 1.27 *



CLOSET RISER

ONE PIECE UNI-CONE RISER WITH LOOSE FERRULE

	SSC No.	Manuf No.	Size	Price Each
	20J 8780	57112	3/8" x 12"	\$.78 *
	20J 8800	57120	3/8" x 20"	1.00 *



ACETAL BALLCOCK NUT

	SSC No.	Manuf No.	Size	Price Each
	20J 8820	53016	3/8"	\$.40 *

For More Information On These Products Or
On Products Not Listed, Call
Salina Supply Company At (785) 823-2221

continued on next page

Viega MANABLOC UNITS & FITTINGS

*Price Change

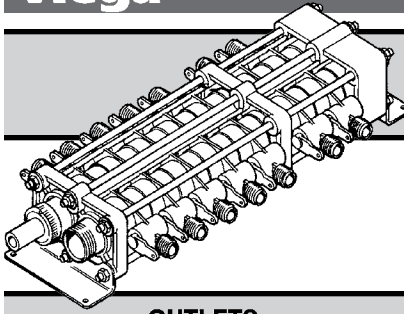

MANABLOC MANIFOLD CONTROL UNIT

COMPACT • HIGH FLOW • QUICK INSTALLING • POSITIVE SEALING
INCLUDES, MOUNTING BRACKETS, DRILL TEMPLATES, INSTRUCTION GUIDES & FACEPLATES.

SSC No.	Manuf No.	Port Size	Total Ports	Hot	Cold	Service Range	Price Each
34N 7010	36243	1/2"	24	12	12	25 to 30	\$ 228.26 *
34N 7020	36303	1/2"	30	12	18	25 to 30	281.62 *

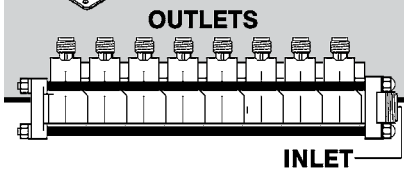

OUTLETS

MINIBLOC MANIFOLD CONTROL UNIT

UNIT INCLUDES MOUNTING BRACKETS, INSTRUCTION GUIDES & FACEPLATES. WITH VALVES.
ALSO INCLUDES HOT & COLD INDEX & LABELS.

SSC No.	Manuf No.	Port Size	Total Ports	Price Each
34N 7040	36083	1/2"	8	\$ 88.65 *

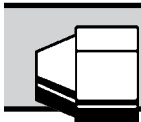

COMPRESSION NUT

FOR 5/8" OD (1/2" NOM) TUBING

SSC No.	Manuf No.	Size Nom.	Price Each
34N 7080	36003	1/2"	\$.94 *



MANABLOC END CAP

SSC No.	Manuf No.	Price Each
34N 8060	53601	\$ 7.45 *

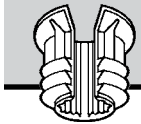

PIPE INSULATOR CLAMP

SSC No.	Manuf No.	Size	Price Each
34N 7100	55120	1/2"	\$.39 *



COMPRESSION CAP

BRASS BARB X MANABLOC

SSC No.	Manuf No.	Size Nom.	Price Each
34N 8080	RXPC4	1/2"	\$.91

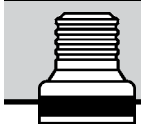

TRANSITION FITTING

PEX X MANABLOC

SSC No.	Manuf No.	Size Nom.	Price Each
34N 8000	48414	3/4"	\$ 8.15

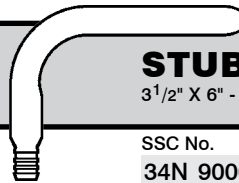

STUB OUT ELBOW

3 1/2" X 6" - 1/2" INSERT X 1/2" CLOSED END

SSC No.	Manuf No.	Size	Price Each
34N 9000	44226	1/2"	\$ 4.87 *

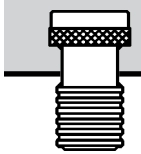

TRANSITION FITTING

MPT X MANABLOC

SSC No.	Manuf No.	Size	Price Each
34N 8020	50646	3/4"	\$ 10.13
34N 8040	50656	1"	16.28

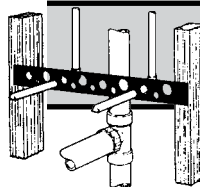

Jones Stephens Corp. COPPER STUD BRACKET

(7) 1/2" NOM., (4) 3/4" NOM. & (4) 1" NOM. HOLES

SSC No.	Manuf No.	Dimensions	Price Each
34K 3760	B00-005	1 3/4" x 20"	\$ 4.51

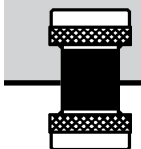

TRANSITION FITTING

MANABLOC X MANABLOC

SSC No.	Manuf No.	Size	Price Each
34N 8030	MSS55	1"	\$ 13.09



STUD GUARD

18 GAUGE • SELF NAILING • 4 1/2" BETWEEN POINTS

SSC No.	Manuf No.	Size	Price Each
34K 3775	33931	1 1/2" x 5"	\$.59 *