

Myers SUBMERSIBLE PUMPS

4" NEMA SUBMERSIBLE PUMPS

1/3, 1/2, 3/4, 1, 1 1/2, 2, 3 & 5 H.P. 5, 8, 12, 30 & 25 GPM 2 Or 3 Wire Versions

Recommended Operating Ranges For 4" Submersible Pumps All Pumps Have 1 1/4" Discharge

Tank Pressure	2 Wire Cat.#	3 Wire Cat.#	Motor H.P.	Volts	GPM	Depth To Water											
						20	40	60	80	100	120	140	160	180	200	250	300
20/40	2ST52-12	3ST52-12	1/2*	230	12			15.0	13.5	12.0	10.3	8.0					
20/40	2ST72-12	3ST72-12	3/4	230	12				15.7	14.7	13.7	12.6	11.2	9.8	8.0		
20/40	2ST102-12	3ST102-12	1	230	12						15.5	14.7	13.7	12.7	11.9	8.7	
20/40	2ST152-12	3ST152-12	1 1/2	230	12										15.6	14.2	12.6
20/40	2ST72-20	3ST72-20	3/4	230	20	23.5	22.0	20.0	17.0								
20/40	2ST102-20	3ST102-20	1	230	20		24.5	23.0	22.0	20.5	18.0	15.5					
20/40	2ST152-20	3ST152-20	1 1/2	230	20				24.5	23.5	22.5	21.5	20.5	19.0	17.0		
20/40	2ST102-25	3ST102-25	1	230	25		27.7	23.5	17.5								
20/40	2ST152-25	3ST152-25	1 1/2	230	25			30.5	27.1	24.0	19.6	15.3					
30/50	2ST52-8	3ST52-8	1/2*	230	8	12.0	11.4	10.8	10.1	9.3	8.3	7.2	5.8				
30/50	2ST72-8	3ST72-8	3/4	230	8				11.5	11.1	10.6	10.0	9.5	8.8	8.0	5.5	
30/50	2ST52-12	3ST52-12	1/2*	230	12		14.5	13.0	11.5	9.8	7.2						
30/50	2ST72-12	3ST72-12	3/4	230	12			15.5	14.5	13.4	12.2	10.9	9.4	7.5			
30/50	2ST102-12	3ST102-12	1	230	12					15.3	14.5	13.5	12.6	11.6	10.5		
30/50	2ST152-12	3ST152-12	1 1/2	230	12									15.4	14.9	13.4	11.7
30/50	2ST72-20	3ST72-20	3/4	230	20	21.5	19.5	16.0									
30/50	2ST102-20	3ST102-20	1	230	20	24.0	23.0	21.5	20.0	17.5	14.5						
30/50	2ST152-20	3ST152-20	1 1/2	230	20			24.5	23.5	22.5	21.5	20.0	18.5	16.5	14.5		
30/50	2ST102-25	3ST102-25	1	230	25	26.7	21.8	16.1									
30/50	2ST152-25	3ST152-25	1 1/2	230	25		30.0	26.6	23.1	19.1	15.0						
40/60	2ST52-8	3ST52-8	1/2*	230	8	11.4	10.8	10.1	9.3	8.3	7.1	5.7					
40/60	2ST72-8	3ST72-8	3/4	230	8			11.5	11.1	10.6	10.0	9.5	8.8	8.0	7.1		
40/60	2ST52-12	3ST52-12	1/2*	230	12	14.5	13.0	11.5	9.8								
40/60	2ST72-12	3ST72-12	3/4	230	12		15.5	14.5	13.4	12.2	10.9	9.4	7.5				
40/60	2ST102-12	3ST102-12	1	230	12				15.3	14.5	13.5	12.6	11.6	10.5	9.2		
40/60	2ST152-12	3ST152-12	1 1/2	230	12								15.4	14.9	14.3	12.8	11.0
40/60	2ST72-20	3ST72-20	3/4	230	20	19.5	16.0										
40/60	2ST102-20	3ST102-20	1	230	20	23.0	21.5	20.0	17.5	14.5							
40/60	2ST152-20	3ST152-20	1 1/2	230	20		24.5	23.5	22.5	21.5	20.0	18.5	16.5	14.5	12.5		
40/60	2ST102-25	3ST102-25	1	230	25	21.4	15.5										
40/60	2ST152-25	3ST152-25	1 1/2	230	25	30.0	26.2	22.8	19.0								

*1/2 H.P. Units Available In 115 Volt Also

WIRE SIZING CHART
2 or 3 Wire Cable, 60 Hz
(Service Entrance to Motor -Maximum Length in Feet)

MOTOR RATING	AWG COPPER WIRE SIZE										
	VOLTS	HP	14	12	10	8	6	4	3	2	1
115	1/2	100	160	250	390	620	960	1190	1460	1780	
	1/3	550	880	1390	2190	3400	5250	6520	7960	9690	
	1/2	400	650	1020	1610	2510	3880	4810	5880	7170	
	3/4	300	480	760	1200	1870	2890	3580	4370	5330	
	1	250	400	630	990	1540	2380	2960	3610	4410	
230	1 1/2	190	310	480	770	1200	1870	2320	2850	3500	

Myers SUBMERSIBLE PUMPS

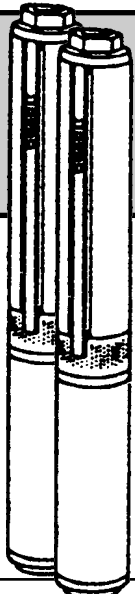

PREDATOR SERIES ST 4" SUBMERSIBLE PUMPS

- STAINLESS STEEL PUMP SHELL, SHAFT, & COUPLING • 1 1/4" NPT CAST STAINLESS STEEL DISCHARGE
- TEFLON® REINFORCED POLYESTER STAGING PROVIDES BETTER HEAT DEFLECTION & LUBRICATION FOR LONGER LIFE IN SANDY & LOW YIELDING WELLS
- THERMAL OVERLOADS HELP EXTEND MOTOR LIFE BY SHUTTING DOWN AN OVERHEATING MOTOR
- PENTEK MOTORS WITH BUILT-IN LIGHTNING PROTECTION
- PENTEK MOTORS ARE APPROXIMATELY 20% MORE EFFICIENT WHEN USED WITH PENTEK CONTROL BOX

SSC No.	Manuf No.	H.P.	Most Effective GPM	Factory Recommended GPM Range	Wires	Voltage	Wgt.	Price Each
2 WIRE MYERS PREDATOR SERIES PUMPS								
50A 5092	2ST51-12+P4	1/2	12	9 to 15	2	115	33 lbs	\$ 422.77
50A 5100	2ST52-8+P4	1/2	8	5 to 11	2	230	34 lbs	444.96
50A 5107	2ST52-12+P4	1/2	12	9 to 15	2	230	33 lbs	422.77
50A 5115	2ST72-8+P4	3/4	8	5 to 11	2	230	38 lbs	547.81
50A 5120	2ST72-12+P4	3/4	12	9 to 15	2	230	37 lbs	539.69
50A 5122	2ST72-20+P4	3/4	20	14 to 24	2	230	36 lbs	581.54
50A 5139	2ST102-20+P4	1	20	14 to 24	2	230	40 lbs	604.65

New!
Myers Pumps With Pentek Electric Motors. Look For "P" In Model Number. Pumps With Pentek Motors Have A 5 Year Warranty.

3 WIRE MYERS PREDATOR SERIES PUMPS

50A 5147	3ST51-12+P4	1/2	12	9 to 15	3	115	32 lbs	434.45
50A 5157	3ST52-12+P4	1/2	12	9 to 15	3	230	32 lbs	434.45
50A 5168	3ST72-12+P4	3/4	12	9 to 15	3	230	35 lbs	539.69
50A 5182	3ST102-12+P4	1	12	9 to 15	3	230	40 lbs	563.51
50A 5184	3ST102-20+P4	1	20	14 to 24	3	230	38 lbs	555.39
50A 5201	3ST152-25+P4	1 1/2	25	15 to 30	3	230	47 lbs	853.11

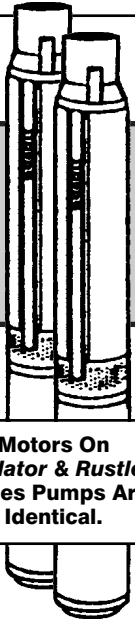

Motors On Predator & Rustler Series Pumps Are Identical.

RUSTLER SERIES 4" SUBMERSIBLE PUMPS

- FIELD REPLACEABLE MOTOR & PUMP END • WATER-COOLED NEMA MOTORS - PENTEK ELECTRIC MOTOR
- STAINLESS STEEL PUMP SHELL, SHAFT, & COUPLING FOR SUPERIOR CORROSION RESISTANCE
- TEFLON® IMPREGNATED POLYESTER STAGING • BUILT-IN POPPET CHECK VALVE • STAINLESS STEEL END CAP
- HIGH-STRENGTH, GLASS-FILLED POLYCARBONATE SUCTION & DISCHARGE BOWLS (1 1/4" NPT)
- INSULATED GROUND LEAD • HYPALON POWER LEADS • PRESSURE EQUALIZING DIAPHRAGM
- PENTEK MOTORS ARE APPROXIMATELY 20% MORE EFFICIENT WHEN USED WITH PENTEK CONTROL BOX

SSC No.	Manuf No.	H.P.	Most Effective GPM	Factory Recommended GPM Range	Wires	Voltage	Wgt.	Price Each
2 WIRE MYERS RUSTLER SERIES PUMPS								
50A 7151	2NFL51-12-P4	1/2	12	9 to 15	2	115	31 lbs	\$ 371.88
50A 7156	2NFL52-12-P4	1/2	12	9 to 15	2	230	31 lbs	371.88
50A 7161	2NFL72-12-P4	3/4	12	9 to 15	2	230	35 lbs	483.64
50A 7171	2NFL102-20-P4	1	20	14 to 24	2	230	36 lbs	536.41

PENTEK CONTROL BOXES FOR MYERS PUMPS

SSC No.	Manuf No.	H.P.	Voltage	Price Each	SSC No.	Manuf No.	H.P.	Voltage	Price Each
50B 3536	SMC-IR0511	.5	115	\$ 49.39	50B 3621	SMC-IR0121	1	230	\$ 53.31
50B 3611	SMC-IR0521	.5	230	47.04	50B 3631	SMC-CR1521	1.5	230	70.93
50B 3616	SMC-IR0721	.75	230	49.28					

continued on next page



Myers SUBMERSIBLE PUMPS CONTINUED

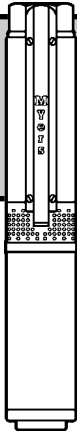

RANGER SERIES 4" HIGH FLOW SUBMERSIBLE PUMP

- 35 GPM • 2" NPT DISCHARGE 1 PH • 230 V • 13.2 AMPS • 3 WIRE
- HEAVY DUTY STAINLESS STEEL CONSTRUCTION • TOUGH CORROSION RESISTANT DESIGN
- ABRASIVE HANDLING DESIGN FOR LONG LIFE • POWERFUL PERFORMANCE • EASY INSTALLATION
- SLIM 3³/₄" DIAMETER EASILY FITS INTO 4" WELLS • NEMA MOUNTING DIMENSIONS
- ENGINEERED THERMOPLASTIC STAGING • BUNA-N SHAFT BEARING

SSC No.	Manuf No.	H.P.	GPM	Wires	Voltage	Wgt.	Price Each
50A 7044	SS20-35	PUMP END 2	35			16 lbs	\$ 626.95
50B 3640	CJF20-21	FRANKLIN 2 HP CONTROL BOX			230	11 lbs	140.80

For More Information On These Products Or On Products Not Listed,
Call *Salina Supply Company* At (785) 823-2221

Myers JET PUMPS

*Price Change

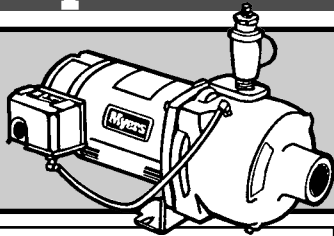

HJ SERIES SHALLOW OR DEEP WELL JET PUMP

WITH BUILT-IN OVERLOAD PROTECTION • 115/30 VOLTS • 1" DISCHARGE

Pump	HJ50S	HJ75S	HJ100S
Press. Set	20/40	20/40	20/40
Disch. PSI	GPM@Disch. Press.		
	5' 14.5@30	23.5@30	27.5@30
Suction Lift	15' 11.5@30	17.5@30	21.0@30
	25' 7.0@30	10.5@40	13.0@40

SSC No.	Manuf No.	H.P.	Discharge	Pump Inlet	Foot Valve	Voltage	Lbs	Price Each
HJ SERIES SHALLOW WELL JET PUMPS								
50A 1150	HJ50S	1/2	1"	1 1/4"	1 1/4"	115/230	44	\$ 407.07
50A 1170	HJ75S	3/4	1"	1 1/4"	1 1/4"	115/230	58	468.64 *
50A 1180	HJ100S	1	1"	1 1/4"	1 1/4"	115/230	75	531.04 *

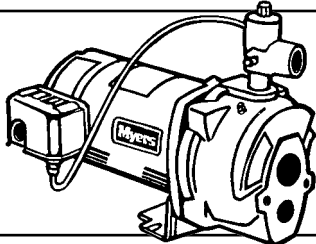

SSC No.	Manuf No.	H.P.	Discharge	Drop Pipe	Foot Valve	Voltage	Lbs	Price Each
HJ SERIES DEEP WELL JET PUMPS								
50A 1110	HJ50D	1/2	1"	1 1/4" x 1"	1"	115/230	44	\$ 407.07
50A 1160	HJ75D	3/4	1"	1 1/4" x 1"	1 1/4"	115/230	58	468.64 *
50A 1175	HJ100D	1	1"	1 1/4" x 1"	1 1/4"	115/230	75	531.04 *

Pump	HJ50D	HJ75D	HJ100D
Jet Package	DW50	DW75	DW100
Max Depth	80	100	110

50H 2500	161/14446A025	Jet Pump Bracket	\$ 40.32
----------	----------------------	-------------------------	----------

TWIN TYPE EJECTOR PACKAGES								
50B 1180	DW50	1/2	Bronze	4" Well Minimum	\$ 143.20 *			
50B 0580	DW75	3/4	Bronze	4" Well Minimum	143.20 *			
50B 1360	DW100	1	Bronze	4" Well Minimum	143.20 *			
50B 2210	SW75/SW4C7		Shallow Well	\$ 116.00 *				

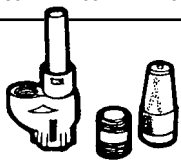

Myers

**blue angel
PUMPS**

CENTRIFUGAL & UTILITY PUMPS

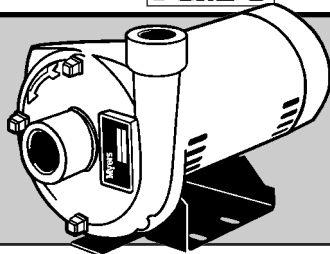

Myers CT SERIES HIGH PRESSURE CENTRIFUGAL PUMPS

1" NPT DISCHARGE • 1 1/4" SUCTION • HEADS UP TO 140' • CAPACITIES TO 95 GPM • RATED TO 212° F
125 PSI MAXIMUM WORKING PRESSURE • BRASS IMPELLER • HEAVY DUTY CAST IRON CONSTRUCTION
BACK PULL-OUT DESIGN • DEPENDABLE, CONTINUOUS DUTY RATED DOUBLE BALL BEARING MOTOR

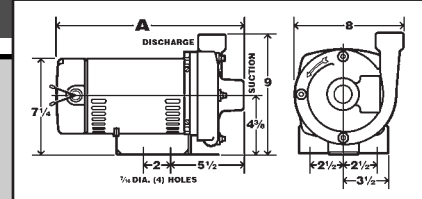

PUMP PERFORMANCE

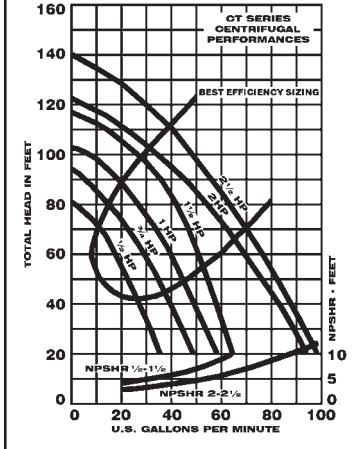

SSC No.	Manuf No.	H.P.	Voltage	A	Phase	Lbs	Price Each
50A 3260	CT05B	1/2	115/230	13 7/8	1	45	\$ 531.47
50A 3310	CT07B	3/4	115/230	14 5/8	1	52	576.22
50A 3360	CT10B	1	115/230	15 1/8	1	55	653.48
50A 3410	CT10B3	1	220/440	15 1/8	3	55	627.51
50A 3460	CT15B	1 1/2	115/230	15 1/8	1	77	681.58
50A 3510	CT15B3	1 1/2	220/440	15 1/8	3	77	703.96

For More Information On These Products Or On Products Not Listed,
Call *Salina Supply Company* At (785) 823-2221

**blue angel
PUMPS**

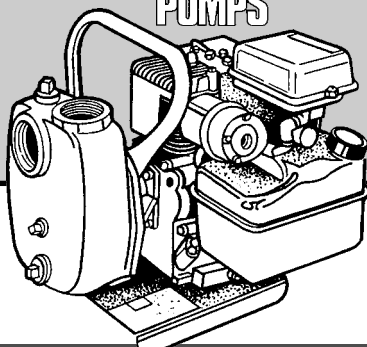

PORTABLE GAS ENGINE UTILITY PUMP

- 3 HORSEPOWER BRIGGS & STRATTON ENGINE
- CAST IRON PUMP HOUSING
- CARBON CERAMIC SEAL
- IMPELLER PUMPS UP TO 3/8" SOLIDS WITHOUT CLOG
- SELF PRIMING - PUMP HOUSING RETAINS WATER

Dynamic Suction Lift	GALLONS PER MINUTE													
	20'		30'		40'		50'		60'		70'		80'	
0'	105	95	83	71	58	46	32							
5'	94	84	72	60	48	36	23							
10'	89	77	60	53	41	29	15							
15'	82	71	48	46	34	21								
20'	76	64	36	40	27	15								
25'	61	55	23	32	20									

SSC No.	Manuf No.	H.P.		Lbs	Price Each
50E 0265	BGP300	3	2" IPS Inlet & Outlet	60	\$ 516.72



MERRILL PUMP & TANK ACCESSORIES

MERRILL CAST IRON WELL SEALS

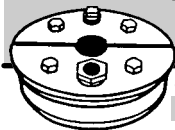

SSC No.	Manuf No.	Size	Price Each
CAST IRON WELL SEALS			
50F 0680	WS400/100	4" x 1"	\$ 15.56

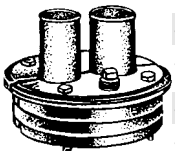

50F 0810	WS500/100	5" x 1"	25.53
50F 0830	WS500/125	5" x 1 1/4"	24.73
50F 0860	WS600/100	6" x 1"	31.11
50F 0880	WS600/125	6" x 1 1/4"	31.11

DOUBLE DROP CAST IRON WELL SEAL

50F 0980	WS522/510	5" x 1 1/4" x 1"	23.93
----------	------------------	------------------	-------

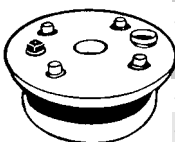

PLASTIC WELL SEALS

50F 1740	WS400/100P	4" x 1"	\$ 13.09
50F 1760	WS400/125P	4" x 1 1/4"	13.09
50F 1810	WS500/100P	5" x 1"	19.68
50F 1840	WS500/125P	5" x 1 1/4"	19.68
50F 1860	WS600/100P	6" x 1"	20.61
50F 1880	WS600/200P	6" x 2"	20.61

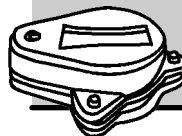

WATER TIGHT & VENTED CONDUIT CAP

SSC No.	Manuf No.	Size	Price Each
50F 2066	WCOS400	4"	\$ 35.90
50F 2068	WCOS500	5"	43.29
50F 2070	WCOS600	6"	51.73



4" CLEARWAY ADAPTER

SSC No.	Manuf No.	Price Each
50F 2075	CW4-10	\$ 90.00

For More Information On These Products Or On Products Not Listed, Call *Salina Supply Company* At (785) 823-2221

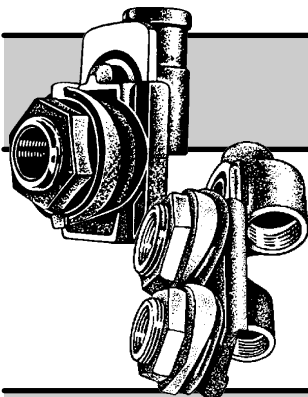

MERRILL PITLESS ADAPTERS

SSC No.	Manuf No.	Size	Price Each
50F 2080	MB50	5" to 8" x 1"	For Wells To 400' \$ 46.34
50F 2085	MB125	5" to 8" x 1 1/4"	For Wells To 300' 103.20
50F 2086	MHB300	6" to 12" x 2"	For Wells To 600' 364.23
50F 2087	MHB400	1" x 1 1/4"	2 Pipe Jet Pitless Adapter \$ 316.68

MERRILL CHECK VALVES

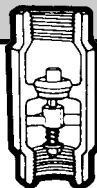

SSC No.	Manuf No.	Size	Tap	Price Each
60G 0100	CVR75	3/4"		\$ 20.94
60G 0150	CVR100	1"		29.77
60G 0200	CVR125	1 1/4"		45.57
60G 0250	CVR150	1 1/2"		55.43
60G 0300	CVR200	2"		99.56
60G 0230	CVM125	1 1/4" M x 1" F		\$ 60.56
60G 0270	CVM1252	1 1/4" M x 1 1/4" F		66.72
60G 0350	CVT1002	1"	1/8"	\$ 58.51
60G 0550	CVT1252	1 1/4"	1/8", 1/4"	62.41

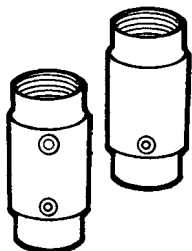

continued on next page

MERRILL PUMP & TANK ACCESSORIES

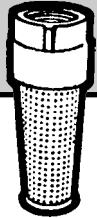

FOOT VALVES

SSC No.	Manuf No.	Size	Price Each
60G 0600	FVR100	1"	\$ 27.51
60G 0650	FVR125	1 1/4"	36.95
60G 0700	FVR150	1 1/2"	49.27
60G 0750	FVR200	2"	84.17



TORQUE STOPS

SSC No.	Manuf No.	Price Each
50F 2160	STA-48C	\$ 9.23

WIRE GUARD TORQUE STOP

50F 2170	CG46	\$ 1.06
----------	-------------	---------

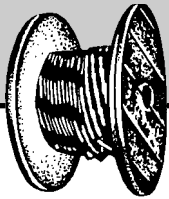
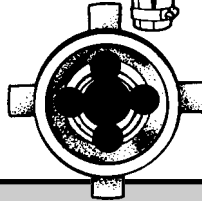

SPOOL OF SUBMERSIBLE PUMP CABLE

SSC No.	Manuf No.	Wire	Gauge	Length	Price Per Foot
50G 0400	10-2+G	77210 PVC	2	1000'	\$ 1.23
50G 0600	12-2+G	77206 PVC	2	1000'	.82
50G 2100	10-3+G	77211 PVC	3	1000'	1.62
50G 2400	12-3+G	77207 PVC	3	1000'	1.09

SSC No.	Manuf No.	Wire	Gauge	Length	Price Per Spool
50G 0615	12-2+G	77206 PVC	2	500'	\$ 406.26
50G 2415	12-3+G	77207 PVC	3	500'	546.12



HEATSHRINK SPLICE KITS

SSC No.	Manuf No.	Wire	Price Each
50F 2175	CSK383	3	\$ 4.72
50F 2180	CSK38344	4	6.13



COMPRESSION SPLICE KITS

SSC No.	Manuf No.	Wire	Price Each
50F 2185	MCSK2	2	\$ 8.96
50F 2190	MCSK3	3	13.05

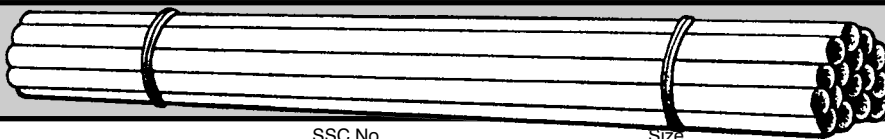

GALVANIZED PUMP ROD

SSC No.	Size	Price Each	Price Per 100 Feet
50F 2430	3/8" x 21'	\$ 45.59	\$ 217.10
50F 2480	7/16" x 21'	56.03	266.81

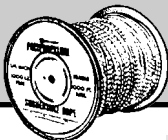

POLYESTER BRAIDED ROPE

SSC No.	Manuf No.	Size	Price Each
50F 2194	SSR500B	1/4" x 500'	\$ 22.44

SSC No.	Manuf No.	Size	Price Per Ft
50F 2195	SSR300B	1/4"	\$.09

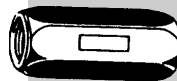

GALVANIZED ROD COUPLINGS

SSC No.	Manuf No.	Size	Price Each
50F 2860	380RC	3/8" x 3/8"	\$ 1.39
50F 2910	716RC	7/16" x 7/16"	1.39
50F 2960	7638RC	7/16" x 3/8"	1.34

PUMP & TANK ACCESSORIES



MERRILL/SQUARE D PRESSURE SWITCHES

9013FSG2 WITH PRESSURE RANGE OF 20 TO 65 PSI OR 9013GSG2 WITH PRESSURE RANGE OF 20 TO 80 PSI

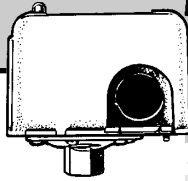

SSC No.	Manuf No.	Pressure Range	Differential	Max HP-1 110 V	Phase AC 220 V	Max HP-Polyphase AC 220	440	550	Price Each
PRESSURE SWITCH FOR DOMESTIC WATER PUMPS									
50F 3660	FSG220	20 to 40 PSI	10 to 30 PSI	1	1 1/2	2			\$ 20.02
50F 3810	FSG230	30 to 50 PSI	10 to 30 PSI	1	1 1/2	2			20.02
50F 3815	FSG240	40 to 60 PSI	10 to 30 PSI	1	1 1/2	2			20.02

PRESSURE SWITCH WITH LO WATER CUT OFF FOR DOMESTIC WATER PUMPS

50F 4110	FSG2M430	30 to 50 PSI	10 to 30 PSI	1	1 1/2	2			\$ 26.40
----------	-----------------	--------------	--------------	---	-------	---	--	--	----------

HEAVY DUTY PRESSURE SWITCH FOR LARGE PUMPS & AIR COMPRESSORS

50F 4130	GSG230HD	30 to 50 PSI	12 to 35 PSI	2	3	5	5	5	\$ 83.06
50F 4140	GHG260HD	60 to 80 PSI		2	3	5			83.06

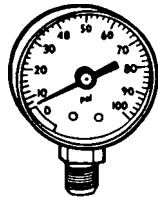

PRESSURE GAUGE

50F 4210	PG100	1/4"	100 PSI Max	2" Dial		.6 lbs			\$ 3.64
----------	--------------	------	-------------	---------	--	--------	--	--	---------

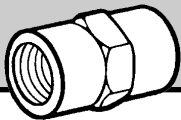

DOLE FLOW CONTROLS

SSC No.	Manuf No.	GPM	FPT	Price Each
50F 9870	FRGC7530	3	3/4"	\$ 51.38
50F 9880	FRGC7550	5	3/4"	51.38
50F 9885	FRGC7570	7	3/4"	51.38
50F 9890	FRGC75100	10	3/4"	51.38
50F 9891	FRGC75115	11.5	3/4"	51.38
50F 9894	FRGX10150	15	1"	78.73
50F 9896	FRGP125200	20	1 1/4"	101.59

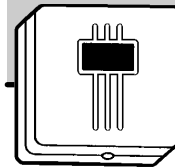

LIQUID LEVEL CONTROL RELAY

110/220 1 HP CONTACT CAPACITY

SSC No.	Manuf No.	Price Each
50F 7920	1500GL1S8N1 X	\$ 262.00



ELECTRODE

STAINLESS STEEL WITH SHIELD

SSC No.	Manuf No.	Price Each
50F 7960	6013-W6	\$ 30.00

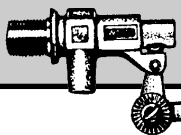

COPPER FLOAT BALLS & STANDARD FLOAT VALVES

SSC No.	Manuf No.	Pipe Size	Stem Fitting	Size	Wgt.	Price Each
STANDARD FLOAT VALVES WITH LOCKNUT & GASKET						
50F 4600	500-12	1/2"	1/4-20	3 1/2" x 2"	0.7 lbs	\$ 44.36
50F 4610	750-12	3/4"	1/4-20	4" x 2"	1.0 lbs	50.88

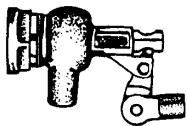

HEAVY DUTY FLOAT VALVES WITH LOCKNUT & GASKET

50F 4620	1000	1"	5/16-18	3" x 4"	1.9 lbs	\$ 88.90
50F 4630	1250	1 1/4"	3/8-16	5 1/2" x 4"	2.3 lbs	150.35

BRONZE STEMS

50F 4632	K-STEM-11	10"	1/4-20 Thrd Valve End	1/4-20 Thrd Float End		\$ 12.60
50F 4634	K-STEM-12.5	12"	5/16-18 Thrd Valve End	3/8-16 Thrd Float End		15.00
50F 4636	K-STEM-13	12"	3/8-16 Thrd Valve End	3/8-16 Thrd Float End		15.00

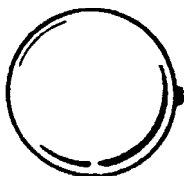

SSC No.	Manuf No.	Diameter	Thread Conn.	Buoyancy (oz)	Wgt.	Price Each
COPPER FLOAT BALLS						
50F 4640	C5	5"	1/4-20	30	0.4 lbs	\$ 51.46
50F 4650	C6	6"	5/16-18		0.5 lbs	59.59
50F 4660	C8	8"	3/8-16	126	1.3 lbs	161.20
50F 4670	C10	10"	3/8-16	250	1.5 lbs	312.27

Myers TANKS & MISC. TANK ACCESSORIES

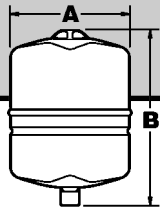

Myers PRO-SOURCE™ PRESSURIZED WATER TANKS

• 180° F MAX OPER. TEMP. • 100 PSI MAX OPER. PRESS. • TANKS SHOULD BE PRECHARGED TO 2 PSI BELOW "ON" PRESSURE

SSC No.	Manuf No.	Vol Gals	Drawdown Gallons			Factory Precharge PSI	A	B	Male or Female Conn.	Wgt Lbs	Price Each
			20-40	30-50	40-60						
50H 0020	PS2-S01	2.0	0.7	0.6	-	40	8.4"	12.6"	3/4" M	12.6	\$ 69.21
50H 0040	PS6-S02	6.0	2.1	1.8	1.6	40	12.0"	16.1"	3/4" M	18.0	118.94

Note: Size tank so drawdown in gallons will equal a minimum of one minute of pump operation
Install a pressure relief valve on any installation where the pump pressure can exceed the tanks maximum pressure

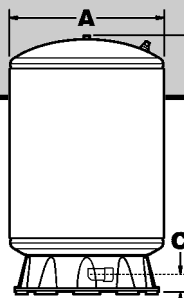

Myers PRO-SOURCE PLUS™ PRESSURIZED WATER TANKS

• 120° F MAX OPER. TEMP. • MAX OPER. PRESS. ON 16" & 20" TANKS IS 100 PSI • MAX OPER. PRESS. ON 24" TANKS IS 125 PSI
• SHOULD BE PRECHARGED TO 2 PSI BELOW "ON" PRESSURE

SSC No.	Manuf No.	Vol Gals	Drawdown Gallons			Factory Precharge PSI	A	B	C	Male or Female Conn.	Wgt Lbs	Price Each
			20-40	30-50	40-60							
50H 0110	PSP19T	19.0	6.9	5.8	5.0	40	16.1	27.8	2.0	1" F	44.0	\$ 173.37
50H 0111	PSP32	32.0	11.6	9.8	8.5	40	16.1	43.0	2.0	1" F	60.0	364.78
50H 0120	PSP35	35.0	12.7	10.7	9.3	40	20.1	33.0	2.0	1" F	70.0	347.41
50H 0135	PSP50	50.0	18.3	15.5	13.4	40	24.1	33.2	2.5	1 1/4" F	88.0	\$ 436.78
50H 0138	PSP85	85.0	30.0	26.0	22.0	40	24.1	51.5	2.5	1 1/4" F	128.0	623.73
50H 0140	PSP119	119.0	41.3	35.4	31.0	40	24.1	68.0	2.5	1 1/4" F	144.0	867.68

Note: Size tank so drawdown in gallons will equal a minimum of one minute of pump operation
Install a pressure relief valve on any installation where the pump pressure can exceed the tanks maximum pressure

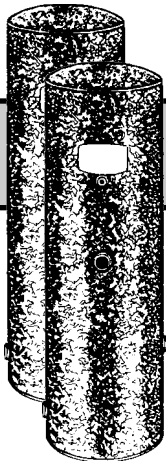

STANDARD GALVANIZED TANKS

SSC No.	Gallons	Maximum Operating Pressure	Size	Lbs	Price Each
50H 0540	21	75 PSI	16" x 26 7/8"	45	\$ 217.38
50H 0560	42	75 PSI	16" x 51"	65	232.02
50H 0580	42	75 PSI	20" x 33 5/8"	71	243.62
50H 0610	82	75 PSI	20" x 63"	114	370.11
50H 0630	120	75 PSI	24" x 64 1/2"	154	430.47

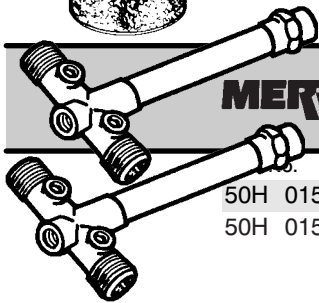

MERRILL TANK TEES

SSC No.	Manuf No.	Size	Lgth	Drain	Control Taps	Price Each
50H 0150	BAT100L	1" MPT	11"	1/2" FPT	(2) 1/4" FPT	\$ 36.96
50H 0155	BAT125X	1 1/4" MPT	13"	3/4" FPT	(2) 1/4" FPT	43.12

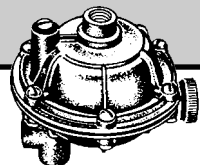

MERRILL/BRADY AIR VOLUME CONTROL LESS KIT

SSC No.	Manuf No.	Maximum Tank Size	Price Each
50H 1330	AV-30	42 Gallons	Less Kit \$ 16.04
50H 1335	AV-42	70 Gallons	Less Kit 22.80
50H 1340	AV-100	120 Gallons	Less Kit 18.08

Myers SEWAGE PUMPS & ACCESSORIES

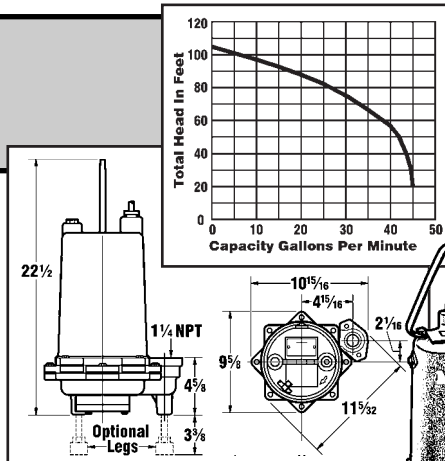

Myers 2 HP RESIDENTIAL GRINDER PUMP

- CUTTER & RECESSED IMPELLER TO MACERATE RAW SEWAGE SOLIDS INTO FINE SLURRY
- SUBMERSIBLE • CAPACITIES TO 45 GPM • HEADS TO 105' • 140° INTERMITTENT LIQUID TEMPERATURE
- 311° WINDING INSULATION TEMPERATURE (CLASS F) • 6-9 ACCEPTABLE PH RANGE
- 3450 RPM • 1 PH - CAPACITOR START/RUN • 230 V • 60 HZ • 15.0 AMPS • 28-35 SSU VISCOSITY
- WITH LEG KIT & PIGGY BACK SWITCH - 230 V/ 1PH/15 AMPS

SSC No.	Manuf No.	H.P.	Voltage	Discharge	Price Each
50E 0013	MRG20-21AK	Pump	2	230 V	1 1/4" NPT \$ 1877.16

For More Information On These Products Or On Products Not Listed, Call *Salina Supply Company* At (785) 823-2221

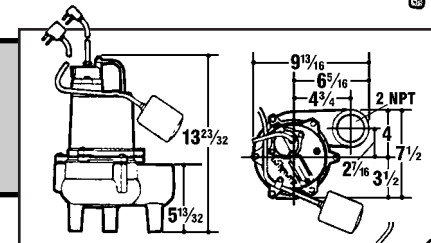

Myers .4 HP OR .5 HP SEWAGE PUMPS

- PIGGY BACK SWITCH ON SRM4 PUMPS - NON PIGGY BACK SWITCH ON CMV5A-11
- FRESH & DRAINAGE EFFLUENT WASTE • 6" TO 6 1/2" PUMP DOWN RANGE
- 2" DIAMETER SOLIDS HANDLING CAPABILITY • .4 HP & .5 HP PUMPS HAVE SAME CAPACITY
- 85° F CONTINUOUS, 140° INTERMITTENT LIQUID TEMPERATURE

SSC No.	Manuf No.	Type	H.P.	Voltage/Amps	Disch.	Price Each
50E 0020	SRM4MIC	Manual	.4	115 V/12A	2"	\$ 352.39
50E 0025	SRM4P-1	Automatic	.4	115 V/12A	2"	346.12
50E 0017	CMV5A-11*	Automatic	.5	115 V/12A	2"	290.13
50E 0065	A2-9I/AD211	115 V	10' Cont. WF Plug	1/2 HP		\$ 51.01

*CMV5A-11 IS NON PIGGY BACK & HAS SLIGHTLY DIFFERENT DIMENSIONS

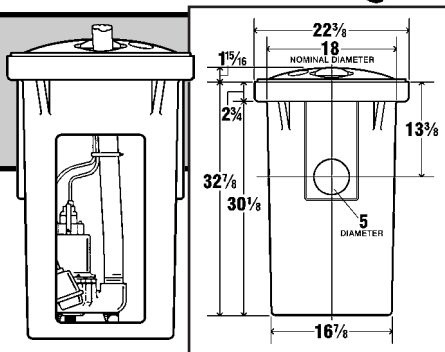
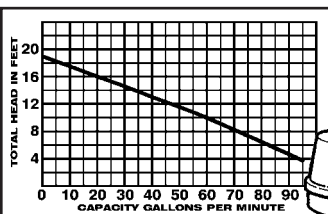

Myers PACKAGED SIMPLEX SEWAGE SYSTEMS

- **SRM4P-1 .4 HP OR CMV5A-11 .5 HP PUMP** • 20' POWER CORD • GAS TIGHT SPLIT COVER
- 18" X 30" (30 GAL) POLYETHYLENE BASIN WITH 4" PLASTIC SLIP TYPE INLET HUB
- FULL SWING 2" COMPRESSION TYPE CHECK VALVE • PUMP DOWN 7" TO 14"

SSC No.	Manuf No.	Type	H.P.	Voltage/Amps	Disch.	Price Each
50E 0030	SR1830-23-2	Automatic	.4	115 V/12A	2"	\$ 564.63
50E 0031	CMV1830*	Automatic	.5	115 V/12A	2"	576.60

*ASSEMBLED **CMV1830** SAME DIMENSIONS AS SHOWN

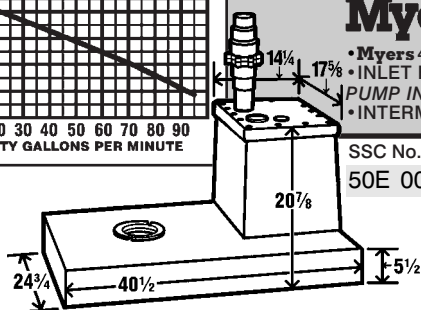
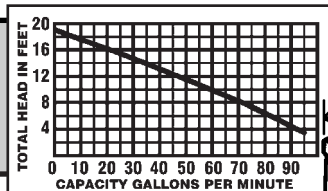

Myers READY JON SEWAGE SYSTEM

- **SEWAGE EJECTOR PUMP UP PACKAGE** • **SRM4S-1 .4 HP (115V) SEWAGE PUMP**
- Myers 40 1/2" X 24 3/4" X 20 7/8" TALL POLY TANK (BASE IS 40 1/2" X 24 3/4" X 5 1/2") • 2" VENT CONNECTION
- INLET FOR STANDARD TOILET • 2" CHECK VALVE/DISCHARGE PIPING ASSEMBLY
- PUMP INFO: • CAPACITIES TO 95 GPM • HEADS TO 18' • 2" SOLIDS HANDLING CAPACITY
- INTERMITTENT LIQUID TEMPERATURE UP TO 140°F • 10' POWER CORD

SSC No.	Manuf No.	H.P.	Voltage/Amps	Disch.	Price Each
50E 0032	MRJ	.4	115 V/12A	2"	\$ 1078.71 *

continued on next page

GOULDS PUMPS, INC.

Little GIANT
Pump Company
www.LittleGiantPump.com ISO 9001

Liberty Pumps SEWAGE PUMPS

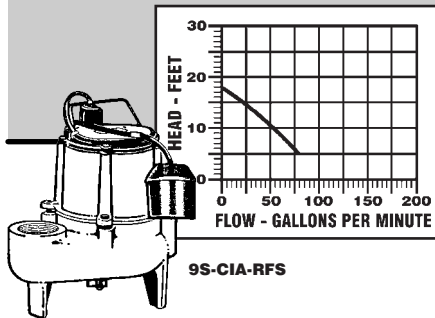

Little GIANT
Pump Company
www.LittleGiantPump.com ISO 9001

AUTOMATIC .4 HP SUBMERSIBLE SEWAGE PUMP

- THIS PUMP HANDLES LIQUIDS & SOLID WASTE UP TO 2" DIAMETER • 15' POWER CORD
- CAST IRON WITH GLASS FILLED NYLON COVER • PIGGY BACK FLOAT SWITCH

SSC No.	Manuf No.	H.P.	Voltage	Discharge	Price Each
50E 0035	9S-CIA-RFS/509500	.4	115 V	2" FNPT	\$ 373.60

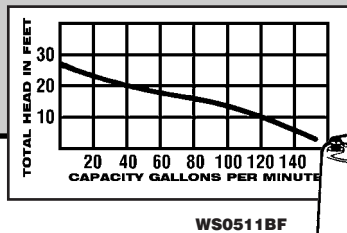

GOULDS PUMPS, INC. .5 HP SEWAGE PUMP

- CAST IRON CASING • CAN RUN DRY WITHOUT COMPONENT DAMAGE • 13.0 MAX AMPS
- 1750 RPM • 104° F CONTINUOUS, 140° INTERMITTENT LIQUID TEMPERATURE
- 2" DIAMETER SOLIDS HANDLING CAPABILITY • **NO SWITCH INCLUDED**

SSC No.	Manuf No.	Type	H.P.	Voltage/Amps	Disch. NPT	Price Ea
50E 0008	WS0511B	Manual	.5	115 V/14.5A	2" <i>Only</i>	\$ 772.34
50E 0010	WS0511BF	Manual	.5	115 V/14.5A	2" (3" <i>Opt</i>)	900.00
50E 0011	A1-3	3" Flange For WS0511BF Sewage Pump				\$ 39.72
50E 0080	A2-5/A2E21	115V		15' Cont. WF Plug	3/4 HP/15A	100.69

WS0511B
2" FPT Only



For More Information On These Products Or On Products Not Listed,
Call **Salina Supply Company** At (785) 823-2221

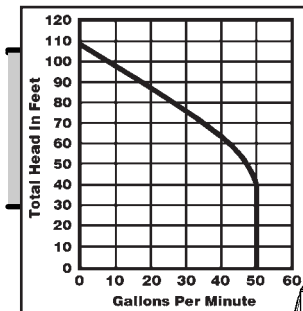

Liberty Pumps OMNIVORE™ AUTOMATIC 2 HP SUBMERSIBLE GRINDER PUMP

- CAST IRON CONSTRUCTION • 208-230 VOLTS • 1 PHASE • 3450 RPM • V-SLICE™ CUTTING SYSTEM
- 25' POWER CORD WITH QUICK-DISCONNECT • PIGGY BACK PLUG WITH WIDE ANGLE FLOAT • 86 LBS

SSC No.	Manuf No.	Automatic	Voltage	Discharge	Price Each
50E 0033	LSG202A		208-230	1 1/4"	\$ 1719.00

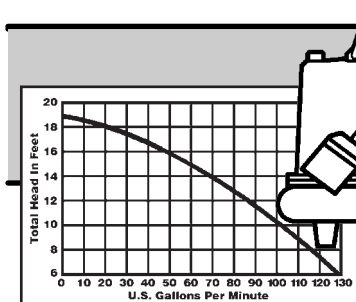
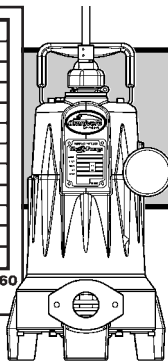

Liberty Pumps AUTOMATIC .4 HP SUBMERSIBLE SEWAGE PUMP

- HANDLES LIQUIDS & SOLID WASTE UP TO 2" DIAMETER • 10' QUICK-DISCONNECT POWER CORD
- CAST IRON BODY • VORTEX IMPELLER • MERCURY FREE WIDE ANGLE FLOAT SWITCH

SSC No.	Manuf No.	Automatic	H.P.	Voltage	Discharge	Price Each
50E 0050	LE41A		.4	115 V	2" FNPT	\$ 365.00

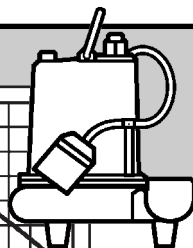

SEWAGE PUMP ACCESSORIES

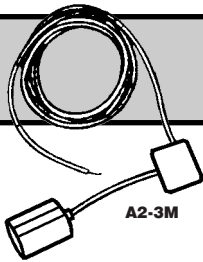

GOULDS PUMPS, INC. A2-3M LEVEL CONTROL

•NON MERCURY •NORMALLY OPEN/PUMP DOWN

SSC No.	Manuf No.	Voltage		Amps	Capacity	Price Each
50E 0070	A2-3M/A2D23W	115 V	15' FS Bare Lead & Wgt	13 A	1/2 HP	\$ 59.56

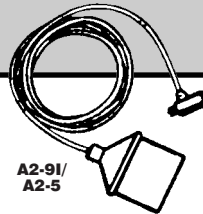

GOULDS PUMPS, INC. LEVEL CONTROLS

•NON MERCURY •NORMALLY OPEN/PUMP DOWN

SSC No.	Manuf No.	Voltage		Amps	Capacity	Price Each
50E 0065	A2-9I/A2D11	115 V	10' WF Plug	13 A	1/2 HP	\$ 51.01
50E 0080	A2-5/A2E21	115V	15' WF Plug	15 A	3/4 HP/15A	100.69
50E 0085	20PMSPTWOP	115V	20' L/ Plug SPDT Switch	13 A	1/2 HP	61.59

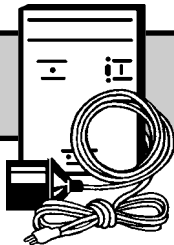

SJE[®] S.J. ELECTRO SYSTEMS, INC. LOW VOLTAGE OPERATED HI WATER ALARM

Quality Liquid Level Controls

SSC No.	Manuf No.				Wgt.	Price Each
50E 0075	101-01H/A4-2	Loud Horn	Warning Light	10' Float Cable	5.0 Lbs	\$ 167.34

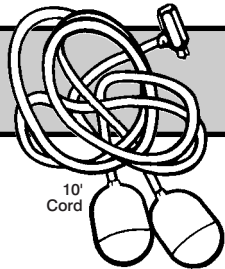

SJE[®] S.J. ELECTRO SYSTEMS, INC. 2 BULB LEVEL CONTROL

Quality Liquid Level Controls

SSC No.	Manuf No.	Voltage		Price Each
50E 0100	15DFD1WP	120 V	15' Cord	\$ 163.08

For More Information On These Products Or On Products Not Listed,
Call *Salina Supply Company* At (785) 823-2221

continued on next page

SEWAGE PUMP ACCESSORIES



Jackel VERTICAL CHECK VALVES

SSC No.	Manuf No.	Size		Price Each
50E 0115	DJ545	1 1/4" x 1 1/2"	Compression x Compression	\$ 12.33
50E 0120	2GP	2"	Compression x Compression	24.06

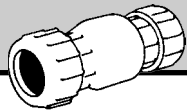

Flo PVC SWING COMPRESSION CHECK VALVES

SSC No.	Manuf No.	IPS Size	Body Length	Wgt.	Price Each
50E 0125	1500-20	2"	9 3/4"	1.14 Lbs	\$ 33.60
50E 0130	1500-30	3"	14"	5.60 Lbs	91.75

For More Information On These Products Or On Products Not Listed,
Call *Salina Supply Company* At (785) 823-2221

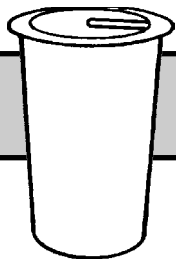

20 GALLON CORRUGATED SUMP PUMP BASIN WITH SLOTTED ECONOMY COVER

SSC No.	Manuf No.	Size	Price Each
50E 0180	B22LPN	Basin & Cover	18" x 22" \$ 47.12

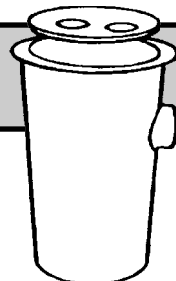

SEWAGE BASIN & COVER WITH SNAP-IN HUB & 4" INLET

SSC No.	Manuf No.	Size	Price Each
50E 0145	B24001RRT	Basin & Cover	18" x 30" \$ 135.58
50E 0185	B33001RRT	Basin & Cover	24" x 30" 229.09

Myers GOULDS PUMPS, INC. SUMP PUMPS

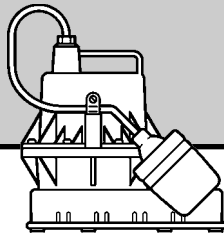

Myers "THE PUP" 1/4 HP RESIDENTIAL SUMP PUMP

- MERCURY-FREE FLOAT SWITCH • NON-CLOGGING RECESSED IMPELLER • BALL BEARING MOTOR
- CAST IRON MOTOR HOUSING • 15 GPM @ 15' TOH • 6.5 AMP • 10' POWER CORD

SSC No.	Manuf No.	Voltage	H.P.	Discharge	Motor	Price Each
50E 0199	SP25A1	110 V	1/4	1 1/2"	3450 RPM	\$ 130.20

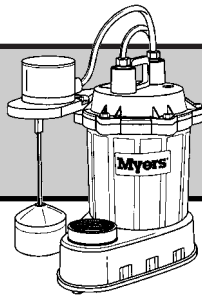

Myers SUBMERSIBLE SUMP & EFFLUENT PUMPS

- MERCURY FLOAT SWITCH • RECESSED IMPELLER • 21 LBS
- HEAVY CAST IRON HOUSING
- P = PIGGY BACK • V = VERTICAL SWITCH

TOTAL HEAD	10'	16'	20'
GALLONS PER HOUR	1530	1140	650

SSC No.	Manuf No.	Voltage	H.P.	Discharge	Motor	Price Each
50E 0206	S-33-V1	110 V	.33	1 1/2"	3000 RPM	\$ 151.03

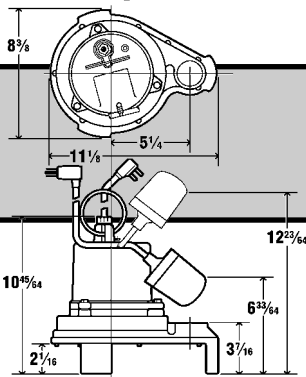

Myers HIGH HEAD SUBMERSIBLE EFFLUENT PUMP

- MECHANICAL FLOAT SWITCH • RECESSED IMPELLER

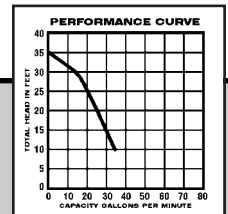

SSC No.	Manuf No.	Voltage	H.P.	Discharge	Motor	Price Each
50E 0015	ME3H-11P	115 V	1/3	1 1/2"	1550 RPM	\$ 467.82

For More Information On These Products Or On Products Not Listed,
Call *Salina Supply Company* At (785) 823-2221

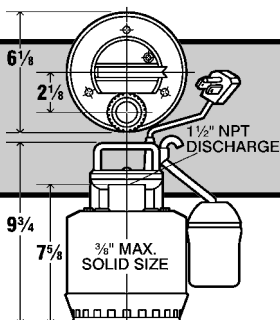

GOULDS PUMPS, INC. SUBMERSIBLE SUMP PUMP

- UPPER & LOWER HEAVY DUTY BALL BEARING CONSTRUCTION
- STAINLESS STEEL SHELL

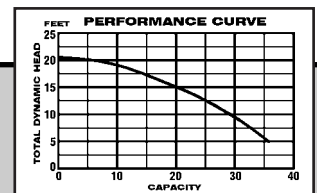

SSC No.	Manuf No.	Voltage	H.P.	Discharge	Motor	Price Each
50E 0012	LSP0311AT	115 V	1/3	1 1/2"	3500 RPM	\$ 274.47

continued on next page



Liberty Pumps SUMP PUMPS

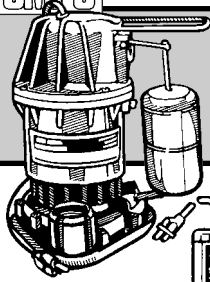

SUBMERSIBLE SUMP PUMP

DISCHARGE HEAD	10'	15'
GALLONS PER HOUR	2270	1640

SSC No.	Manuf No.		H.P.		Wgt.	Price Each
50E 0241	BSPF-33	Submersible	1/3		13 Lbs	\$ 157.97



UPRIGHT PEDESTAL SUMP PUMPS

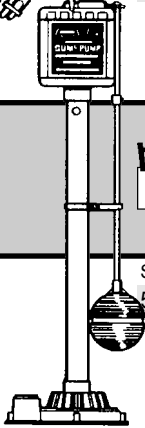

DISCHARGE HEAD	10'	15'
GALLONS PER HOUR	2270	1640

SSC No.	Manuf No.		H.P.		Wgt.	Price Each
50E 0240	BTU-33	Pedestal	1/3	Thermoplastic	15 Lbs	\$ 106.44

Liberty Pumps SUMP PUMP

- VMF SWITCH (MAGNETICALLY OPERATED VERTICAL FLOAT) • 1/2" SOLIDS HANDLING
- 140°F MAX TEMPERATURE • QUICK-DISCONNECT 10' STANDARD POWER CORD
- THERMALLY PROTECTED & PERMANENTLY LUBRICATED • 2 YEAR LIMITED WARRANTY

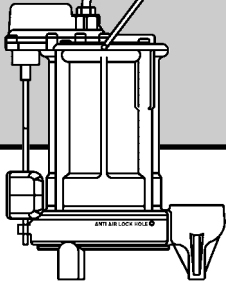
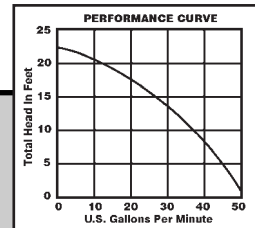

SSC No.	Manuf No.	Voltage	H.P.	Discharge	Wgt.	Price Each
50E 0040	257 VMF	115 V	1/3	1 1/2"	23 Lbs	\$ 174.32

Liberty Pumps SUMP JET WATER POWERED BACK-UP SUMP PUMP

- REQUIRES NO ELECTRICITY • WORKS OFF MUNICIPAL WATER SUPPLY • 20 PSI TO 100 PSI INLET PRESSURE
- HIGH-OUTPUT FLOW RATES • FULLY AUTOMATIC • FULLY ASSEMBLED • 3/4" NPT INLET CONNECTION

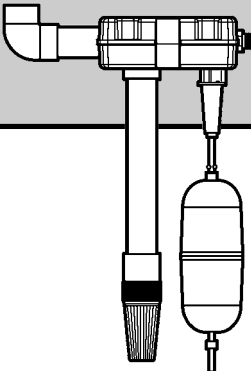

SSC No.	Manuf No.		Discharge	Inlet PSI	Inlet Conn.	Price Each
50E 0038	SJ10	Automatic	1 1/2"	20 To 100	3/4"	\$ 227.88

SJ10 PUMP SUMP WATER REMOVAL AT VARIOUS HEADS (STATIC HEAD IN 1 1/2" PIPE OR LARGER)									
Lift*	4'		8'		12'		15'		
PSI	GPM	GPH	GPM	GPH	GPM	GPH	GPM	GPH	
20	11.0	660	5.8	348	-	-	-	-	
30	12.8	765	9.0	540	5.5	330	-	-	
40	15.4	924	12.5	750	9.3	558	7.2	432	
50	17.2	1032	14.5	870	12.0	720	10.0	600	
60	19.8	1185	17.0	1020	15.2	912	13.5	810	

* (WATER PRESSURE VALVE AT INLET - VALVE OPEN & WATER FLOWING)

continued on next page





SUMP PUMPS • UTILITY PUMPS • CONDENSATE PUMPS

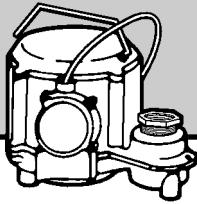

BIG JOHN SUMP PUMP

- SUBMERSIBLE PUMP • AUTOMATIC • 8' CORD
- 1 1/2" FNPT DISCHARGE WITH 1 1/4" FNPT ADAPTER

FEET ABOVE PUMP	5'	10'	15'
GALLONS PER HOUR	2750	1750	750

SSC No.	Manuf No.	Voltage	H.P.	PSI	Wgt	Price Each
50E 0190	6-CIA	115 V	3/10	7.8	18 Lbs	\$ 162.32



DRAINOSAUR WATER REMOVAL SYSTEM

- PREASSEMBLED • 5 GALLON POLYPROPYLENE TANK • BIG JOHN 6-CIA PUMP WITH 8' CORD
- EASY TO REMOVE FILTER TRAP • 1 1/2" DIAMETER PIPE FROM PUMP TO LID
- LID HAS 1 1/2" FNPT SIDE INTAKE PORT, 1 1/2" FNPT TOP DISCHARGE PORT & 2" FNPT TOP VENT PORT

SSC No.	Manuf No.	Dimensions	Wgt	Price Each
50E 0195	WRS-6 With 6-CIA Pump	16" H x 14 1/2" Dia.	23 Lbs	\$ 276.76

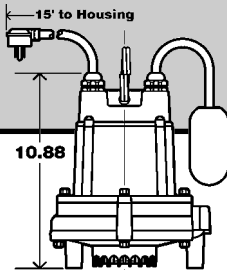

HI TEMPERATURE SUMP PUMP

- SUBMERSIBLE • AUTOMATIC • 20' LIFT • 15' CORD
- 1 1/2" FNPT DISCHARGE • 1/2" DIAMETER WASTE SOLIDS
- CAPABLE OF PUMPING UP TO 200° F. LIQUID
- USES INCLUDE BOILER BLOW-DOWN SUMP PITS

SSC No.	Manuf No.	Voltage	H.P.	PSI	Wgt	Price Each
50E 0192	HT-6E -CIA-FS	115 V	1/3	8.7	32 Lbs	\$ 488.00

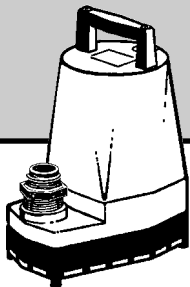

WATER WIZARD UTILITY PUMP

- SUBMERSIBLE • PUMPS DRY TO 1/8" • 18' CORD

FEET ABOVE PUMP	5'	10'	20'
GALLONS PER MINUTE	19	15	5

SSC No.	Manuf No.	Voltage	H.P.	PSI	Wgt	Price Each
50E 0197	5-MSP25	120 V	1/6	11.4	8 Lbs	\$ 148.10

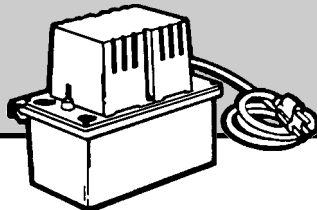

CONDENSATE PUMPS

- CHECK VALVE • .45 GALLON TANK CAPACITY • 6.3 LBS
- 8.6 PSI • 20 SHUTOFF • 20' OF 3/8" TUBING

DISCHARGE HEAD	1'	5'	9'	15'
GALLONS PER HOUR	80	70	55	25

SSC No.	Manuf No.	Amps/Watts	H.P.	PSI	Wgt	Price Each
50E 0315	VCM-20-ULT	1.5/93	1/30	3/8" OD Discharge		\$ 65.08
50E 0316	VCM-20-ULST	1.5/93	1/30	Safety Switch		68.82



50E 0320	CP-6500/540004	Non Submersible Pump	1/70 HP	115V	\$ 33.39
50E 0330	4E-34NR/504203	Submersible Utility Pump	1/12 HP	115V	205.20



WOOD BROS. IND. II
A DIVISION OF MITICHRIS INC.

WATER SOFTENERS

*Price Change **New Product



GE/OSMONICS LOGIX 2 TANK WATER SOFTENERS

MINERAL TANK WITH BRASS BACK PLATE • TOP BASKET LESS BYPASS

For Micro-Processor In Lieu Of 7 Day Timer On Water Softeners, Add Approximately \$160.00

For Water With 2 to 5 ppm Of Iron, Use 200D Turbulator In Softener Add Approximately \$50.00

SSC No.	Manuf No.	Brine Tank	Mineral Tank	Regeneration	Wgt	Price Each
50I 0750	255-740/24K	18" x 30"	8" x 44"	7 Day Clock	86 Lbs	\$ 597.75 **
50I 0752	255-740/32K	18" x 30"	9" x 48"	7 Day Clock	103 Lbs	646.98 **
50I 0754	255-740/48K	18" x 30"	10" x 54"	7 Day Clock	135 Lbs	863.25 **
50I 0760	255-760/24K	18" x 30"	8" x 44"	Micro Processor	86 Lbs	731.12 **
50I 0764	255-760/32K	18" x 30"	9" x 48"	Micro Processor	103 Lbs	782.21 **

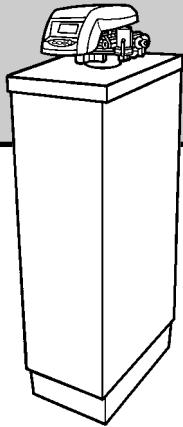

GE/OSMONICS LOGIX 1 TANK CABINET WATER SOFTENERS

MINERAL TANK WITH BRASS BACK PLATE • TOP BASKET LESS BYPASS

For Micro-Processor In Lieu Of 7 Day Timer On Water Softeners, Add Approximately \$160.00

For Water With 2 to 5 ppm Of Iron, Use 200D Turbulator In Softener Add Approximately \$50.00

SSC No.	Manuf No.	Brine Tank	Mineral Tank	Regeneration	Wgt	Price Each
50I 0758	255-740/C24	Cabinet	9" x 35"	7 Day Clock	90 Lbs	\$ 731.12 **
50I 0756	255-760/C24	Cabinet	9" x 35"	Micro Processor	90 Lbs	787.36 **
50I 0762	255-760/C32	Cabinet	10" x 35"	Micro Processor	107 Lbs	823.04 **

SSC No.	Product	Wgt. Lbs.	Price Each
50I 0740	3/4" PLASTIC BYPASS & TAILPIECE	1.11	\$ 57.66
Non Stock	TURBULATOR		Approximately 50.00 *

WARRANTY INFO FOR CURRENT SOFTENERS

- **AUTOTROL 255 (740 & 760):**
5 YEARS FROM MFGR DATE
- **POLY BRINE TANKS:**
5 YEARS FROM MFGR DATE
- **MINERAL TANKS:**
 - 6" TO 13" DIAMETER*
5 YEARS FROM MFGR DATE
 - OTHER SIZES
5 YEARS FROM MFGR DATE

*OLDER UNITS MAY HAVE ONLY A 5 YEAR WARRANTY

Softener No.	255-760	255-760	255-740	255-740	255-740
GRAIN CAPACITY PER REGENERATION	24000	32000	24000	32000	48000
POUNDS SALT PER REGENERATION	Adj	Adj	Adj	Adj	Adj
GRAINS HARDNESS MAXIMUM	30	30	30	40	60
IRON MAXIMUM PPM	2	2	2	2	2
CONTINUOUS SERVICE FLOW GPM @ 15 PSI	10 gpm	10 gpm	10 gpm	10 gpm	10 gpm
PEAK SERVICE FLOW @ 25# PSI DROP	15 gpm	16 gpm	16 gpm	16 gpm	16 gpm
WORKING PRESSURE PSI	20 to 80	20 to 80	20 to 80	20 to 80	20 to 80
PIPE SIZE IN INCHES	3/4"	3/4"	3/4"	3/4"	3/4"
POWER IN VOLTS AC	115 V	115 V	115 V	115 V	115 V
MAXIMUM TEMPERATURE °F	100°	100°	100°	100°	100°
SHIPPING WEIGHT IN POUNDS	90 lbs	107 lbs	86 lbs	103 lbs	135 lbs
MINERAL CONTENT IN CUBIC FEET	3/4	1	3/4	1	1 1/2
DRAIN CONNECTION IN INCHES FPT	1/2"	1/2"	1/2"	1/2"	1/2"
LENGTH OF ELECTRICAL CORD	60"	60"	60"	60"	60"

SALT CAPACITY OF CABINET SOFTENER: 200#
SALT CAPACITY OF 2 TANK SOFTENER: (18 X 30 BRINE TANK) 300#

For More Information On These Products Or On Products Not Listed,
Call **Salina Supply Company** At (785) 823-2221





REVERSE OSMOSIS

* Price Change
** Product Change

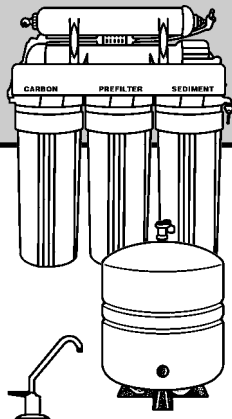

AQUARIUS 5 STAGE REVERSE OSMOSIS SYSTEM

SSC No.	Manuf No.	Product	Wgt. Lbs.	Price Each
50l 0770	RO-EZ50	Nominal 35 Gallon/Day 50 GPD 3/8" Tube		\$ 239.58
50l 0773	PR5/RO	Replacement Filter Kit For PR5/RO		\$ 38.96
50l 0775	150233	TFC Membrane 50 GPD		50.44
	AG-	Faucet With Air Gap	Chrome	\$ 52.82
	NAG-	Faucet Less Air Gap	Chrome	31.48

Source Water Supply - TFC	
Community/Private	Non Chlorinated
System Pressure	30-100 psi
Temperature	40° - 100° F
pH Range	3.0 - 11.0
Maximum Supply TDS Level	<350 mg/L (<20 gpg)
Turbidity	<1.0 Net Turbidity (NTU)

Chemical Parameters - TFC	
Hardness (CaCO ₃)	<350 mg/L (<20 gpg)
Iron (Fe)	<0.1 mg/L
Maganese (Mn)	<0.05 mg/L
Hydrogen Sulfide (H ₂ S)	<0.00 mg/L

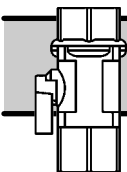

JOHN GUEST PLASTIC BALL VALVES

SSC No.	Manuf No.	Size	Price Each
50l 3231	G020625	3/8" OD	\$ 9.79 *
50l 3232	G0420425	1/4" OD	9.56

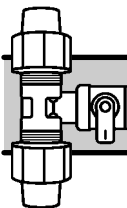

JOHN GUEST RO PAL + VALVE

SSC No.	Manuf No.	Size	Price Each
50l 3235	A-0630425	3/8" x 1/4"	\$ 22.56

JOHN GUEST FITTINGS

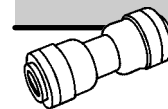

SSC No.	Manuf No.	Size	Price Each
RO COUPLING			
50l 3240	R-0420426	1/4" OD	\$ 2.88
50l 3245	R-0620626	3/8" OD	3.91

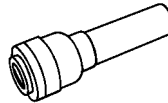

SSC No.	Manuf No.	Size	Price Each
RO BUSHING			
50l 3250	S-0420666	3/8" x 1/4"	\$ 3.03

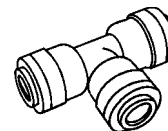

SSC No.	Manuf No.	Size	Price Each
RO TEE			
50l 3254	V-0420426	1/4" OD	\$ 4.10
50l 3255	V-0620626	3/8" OD	5.53

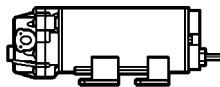

50l 0772	6840-1/4	RO Booster Pump	T50 Transformer	\$156.67 **
----------	-----------------	------------------------	-----------------	-------------



REVERSE OSMOSIS REPLACEMENT FILTERS & ACCESSORIES

* Price Change
** New Product

SSC No.	Manuf No.	Product	Price Each
50l 3011	AP117	Taste/Odor Filter Cartridge 3 gpm 5 Microns	\$ 34.90 **
50l 2861	AP110	Sediment/Dirt/Rust Cartridge 6 gpm 5 Microns	14.82
50l 3228	RM-TFC	Replacement TFCM Membrane For AP-05000	266.09
50l 3128	AP327	Replacement Cartridge For AP310	39.60
50l 3218	55815-47	Reverse Osmosis Monitor For AP-05000	81.39
50l 3220	RO3RC/6850801	Cartridges For Old RO3RC R.O. Unit	Pkg of 3 131.62
50l 3222	55981-01/AP5527	Cartridges For APRO5500 R.O. Unit	Set of 2 142.91
50l 3230	APHWK	Cuno Water Test Kit	21.05

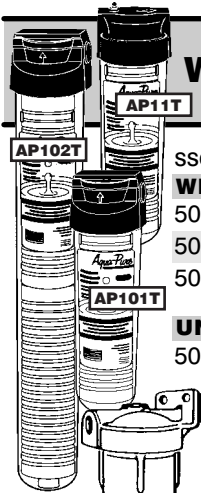

WATER FILTER HOUSINGS

SSC No.	Manuf No.	Housing	GPM	Conn.	Max. Temp.	Max. Pressure	Cartridge Info (No. Used)Included	Valve In Head	Price Each
WHOLE HOUSE CLEAR PLASTIC FILTER HOUSINGS - COLD WATER									
50l 2530	AP11T	Clear Plastic	8.0	3/4"	100°	125 PSI	(1) AP110H/C	No	\$ 125.46
50l 2771	AP101T	Clear Plastic	6.0	3/4"	100°	125 PSI	(1) AP110H/C	Yes	155.50
50l 2776	AP102T	Clear Plastic	12.0	3/4"	100°	125 PSI	(2)None	Yes	213.88
UNDER SINK MOLDED PLASTIC FILTER HOUSING - COLD WATER									
50l 3115	AP200	Molded Plastic	2.0	3/8"		125 PSI	(1) AP217		145.34

FILTERFINDER REFERENCE CHART ☉ Included with Filter ☆ Fits Housing But Not Included

HOUSINGS	DIRT/RUST				TASTE/ODOR DIRT/RUST	SCALE DIRT/RUST	SCALE/TASTE/ODOR DIRT/RUST			
	AP110H/C	AP111H/C	AP124H/C	AP205	AP217	AP117	AP420	AP217	AP117	AP317
AP101S	☉	☆	☆			☆	☆		☆	
AP101T	☉	☆	☆			☆	☆		☆	
AP102T	☆	☆	☆			☆	☆		☆	
AP11S	☉	☆	☆			☆	☆		☆	
AP200				☆	☉				☆	
SERIES AP300										☉

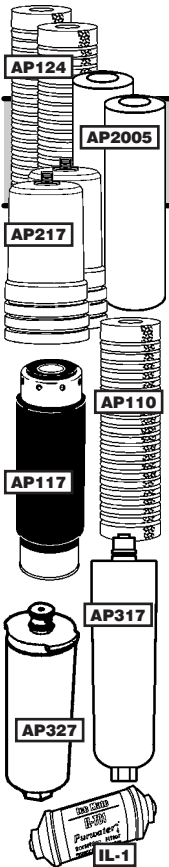

WATER FILTER CARTRIDGES

SSC No.	Manuf No.	For Filter No.	GPM	Microns	Price Per Pair
WATER FILTER CARTRIDGES PRICED PER PAIR					
50l 3110	AP124	AP100 AP1610**	6.0	50	Sediment/Dirt/Rust \$ 34.47
50l 3120	AP217	AP200	2.0	5	Dirt/Rust/Taste/Odor 84.26
50l 3211	AP2005	Hot & Cold 170°	8.0	5	Sediment/Backwash Applications 25.79

SSC No.	Manuf No.	For Filter No.	GPM	Microns	Price Each
WATER FILTER CARTRIDGES PRICED PER EACH					
50l 2861	AP110	AP100 AP1610*	6.0	5	Sediment/Dirt/Rust \$ 14.82
50l 3011	AP117	AP11/101	3.0	5	Taste/Odor 34.90
50l 3126	AP317	AP300	0.5	5	Dirt/Rust/Taste/Odor/Scale 67.54
50l 3128	AP327	AP310	0.5	5	Dirt/Rust/Taste/Odor/Scale 39.60
50l 3130	IL-IM-01	1/4" Ice Maker Filter	0.5		11.68

*Maximum Temperature 210° **Maximum Temperature 100°

For More Information On These Products Or On Products Not Listed,
Call *Salina Supply Company* At (785) 823-2221



Note: All Prices On This Page Have Changed



HOT WATER PROTECTION SYSTEM

- STAINLESS STEEL • FOR COLD WATER FEED LINE • MAINTAINS EFFICIENCY OF HOT WATER SYSTEM
- PREVENTS SCALE BUILD-UP & CORROSION OF PIPES

SSC No.	Manuf No.	Housing	GPM	Conn.	Max. Temp.	Max. Pressure	Price Each
50l 3131	AP430SS	Stainless Steel	6.0	3/4"	100°	125 PSI	\$ 98.11



HOT WATER PROTECTION SYSTEM FILTER CARTRIDGE

SSC No.	Manuf No.	For Filter No.	GPM	Max. Temp.	Price Each
50l 3132	AP431	AP430SS	6.0	100° Max. Temp.	\$ 40.29

For More Information On These Products Or On Products Not Listed,
Call *Salina Supply Company* At (785) 823-2221

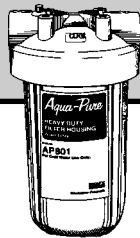

WHOLE HOUSE HEAVY DUTY WATER FILTER HOUSING

- FULL SUMP WRENCH MAKES CARTRIDGE REPLACEMENT EASY & PREVENTS SUMP DAMAGE • 2 YEAR WARRANTY
- PRESSURE RELIEF BUTTON FOR EASY CARTRIDGE REPLACEMENT • POWDER COATED BRACKET KIT (OPTIONAL)
- MADE OF FDA COMPLIANT MATERIALS • EASY TO INSTALL • CARTRIDGE NOT INCLUDED

SSC No.	Manuf No.	Housing	Max. GPM	Max. Conn.	Cartridge Temp.	Cartridge Pressure	Cartridge Used	Price Each
50l 2500	AP801	Opaque Plastic	20.0	1" NPT	100°	100 PSI	AP810 (Not Included)	\$ 121.86
50l 2515	MB801/68901-31 Mounting Kit For AP801							27.90

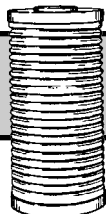

HEAVY DUTY CARTRIDGE FOR WHOLE HOUSE FILTER

- HIGH FLOW GRADED DENSITY CELLULOSE CARTRIDGE FOR EFFICIENT FILTRATION & LONG LIFE
- FOR COLD WATER SERVICE • MAXIMUM TEMPERATURE IS 100° F & MINIMUM IS 40° F
- TRAPS PARTICLES AS SMALL AS 5 MICRONS

SSC No.	Manuf No.	For Filter No.	GPM	Microns	Price Each
50l 2510	AP810	AP801	20.0	5 Sediment/Dirt/Rust	\$ 39.24

continued on next page



*Price Change

LMI
Series A
Metering Pump

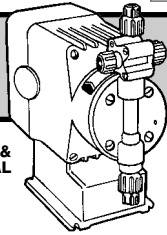

COMMERCIAL & INDUSTRIAL

SERIES A CHEMICAL METERING PUMP

- 24 TO 24 GPD OUTPUT CAPACITY • 110 PSI MAX INJECTION PRESSURE • MANUAL CONTROL
- PROVIDES OUTPUT RANGES OF 100:1 • PULSE OPERATED • .375" TUBING CONNECTION
- OFFERS VERSATILITY OF INDEPENDENTLY ADJUSTABLE STROKE LENGTH & FREQUENCY

SSC No.	Manuf No.	Voltage	Size	Wgt	Price Each
50I 3815	A151-490B1	115 V	4.05" W x 8" H x 9.25" L	15 lbs	\$ 886.80 *
	RPM-392	Spare Parts Kit For A151-490BI Pump		.2 lbs	\$ 77.00

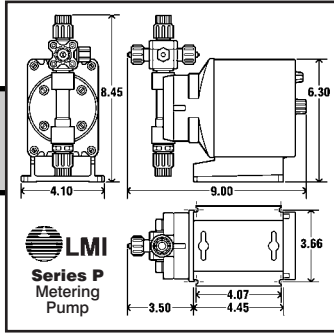

LMI
Series P
Metering Pump

SERIES P ELECTRONIC CHEMICAL METERING PUMP

- 5 GPD OUTPUT CAPACITY • 150 PSI MAX INJECTION PRESSURE • DUAL MANUAL CONTROL
- SPEED (STROKING FREQUENCY) & STROKE LENGTH MANUALLY ADJUSTABLE • PULSE OPERATED

SSC No.	Manuf No.	Voltage	Size	Wgt	Price Each
50I 3830	P121-352SI	115 V	9" W x 6.3" H x 4.1" D	7.6 lbs	\$ 596.43 *

GOULDS PUMPS, INC. HIGH PRESSURE WATERGUN

- 3/4 HP • 3500 RPM • 180° F MAX TEMPERATURE • 3/4" SUCTION & DISCHARGE • 75 PSI MAX INLET PRESSURE

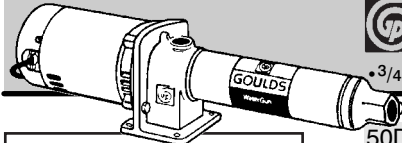

No.	Manuf No.	Voltage	Size	Wgt	Price Each
50D 2300	7GBC07/HB707	115/230/60/1	22 1/8" L x 10 3/8" H	45 lbs	\$ 861.02

Composite Performance Curve
At 0 Lbs Suction Pressure

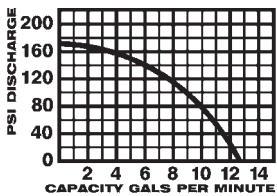

For More Information On These Products Or On Products Not Listed,
Call *Salina Supply Company* At (785) 823-2221

50I 3510	400KL	Platform Scale (Grey)	350 Lb Cap.	37.6 lbs	\$ 330.66
50I 3880	CN-66F	Free Chlorine Test Kit	2231-02	1.0 lbs	88.80
50I 3881	1730-06	Pack of 6 Tubes	No Break		37.87
50I 3885	14076-99	Total Chlorine Regent	100 Pak		39.60
50I 3890	14077-99	Free Chlorine Regent	100 Pak	0.4 lbs	40.80
50I 3891	1453-00	5B Hardness Test			29.00
50I 3893	426.32	#3 Hardness Sol.		4.0 Lbs	24.51
50I 3894	962-99	Univers3	Pak of 100		33.07
50I 3960		Granular Chlorine	100 Lb Drum	100 lbs	258.29
50I 3892	HA95A/1456-02	HD & Iron Tester			61.30
50I 4210		Ortho Tolidine		16.0 Oz	22.27
50I 4310		Potassium Permanganate		5.0 Lbs	32.84